



Twin Otter

DESIGNED BY:

Giuseppe Tompazini



SUPER PNP
Instruction Manual

FLEXTM
INNOVATIONS
www.flexinnovations.com



BEFORE CONTINUING WITH THIS INSTRUCTION MANUAL OR ASSEMBLY OF YOUR TWIN OTTER 80E, PLEASE VISIT OUR WIKI SUPPORT SITE FOR THE LATEST PRODUCT UPDATES, FEATURE CHANGES, MANUAL ADDENDUMS AND FIRMWARE CHANGES FOR BOTH YOUR TWIN OTTER 80E AND THE INSTALLED AURA 8 ADVANCED FLIGHT CONTROL SYSTEM.

**wiki.flexinnovations.com/wiki/TwinOtter_80E
wiki.flexinnovations.com/wiki/Aura**

TABLE OF CONTENTS

Introduction.....	2	Aura 8 Servo Connections.....	14
Includes/Requires	2	Transmitter Setup.....	15
Specifications	3	Receiver Installation	15
Completion Items	3	Connecting Your Receiver to Aura	16
Optional Items	3	Rudder and Elevator Linkage Installation	17
Replacement Parts Listing.....	3	Rudder and Elevator Linkage Installation (continued).....	18
Special Language Definition.....	4	Connecting Battery/Arming ESC	19
Important Information Regarding Warranty.....	4	ESC Throttle Calibration	19
Safety Warnings and Precautions.....	4	Control Direction Test	20
Low Voltage Cutoff	4	Aura Sensor Direction Test.....	21
Before you Begin.....	5	Nose Cone, Cowling, Propeller and Spinner Installation.....	22
Battery Charging Guidelines.....	5	Battery Installation.....	23
Main Landing Gear Installation.....	6	Center of Gravity Verification	23
Nose Gear Installation	7	Pre-flight Checklist.....	24
Tail Installation	8	AMA Safety Code.....	24
Horizontal Stabilizer Installation	9	Twin Otter 80E Aura Optional Features Configuration	25
Motor Installation.....	10	Flying your Twin Otter 80E.....	26
Main Wing Installation.....	11	Airframe Repairs	27
Main Wing Installation (continued)	12	Replacing Servos	27
Night Twin Otter 80E LED Connections.....	13	Aircraft Troubleshooting Guide.....	28
Connecting a Battery to the LED Controller	13	Limited Warranty	29
Aura 8 AFCS	14	Compliance Information for the European Union.....	29

INTRODUCTION

The Flex Innovations Twin Otter 80E offers something incredible for everyone. At first glance, it is a forgiving general twin engine aviation aircraft with rough field capabilities but take a deeper look into the heart of the Twin Otter, and you'll find its expansive capabilities. From wild 3D aerobatics, to a gentle touch and the ability for land or water, this incredible aircraft offers a perfectly balanced airframe for all flying styles

Combine such an incredible airframe with today's most Advanced Flight Control System, the Aura 8 AFCS (included), and you'll get an unmatched flying experience unavailable anywhere else. The twin counter rotating motors cancel torque making the airplane more forgiving. When Aura is set to Flight Mode 3, the gyro rudder gain and rate is looped to the motors providing unbelievable additional stability in forward flight as well as in hovering flight. This differential thrust is also coupled with the rudder control bringing aerobatic capabilities to the next level. The large flaps offer incredible lift, allowing the Twin Otter to fly at "walking speeds". Large control surfaces offer strong control authority at all air speeds. Additionally, the Twin Otter 80E can also be equipped with floats for flying off water.

The Twin Otter 80E is the go-to, all around perfect airplane for maximum fun, unthinkable aerobatics, and minimal hassle. From sport flying, touch and goes, to 3D aerobatics, crazy yaw maneuvering and float flying, the Twin Otter 80E is sure to be your favorite daily flier that can do it all! Available in day and night version with LED lights pre-installed.

For the latest updates, features, addendums and more, before assembly, please visit:

wiki.flexinnovations.com/wiki/TwinOtter_80E

wiki.flexinnovations.com/wiki/Aura

- Pre-installed and custom-tuned Aura 8 Advanced Flight Control System with bounce-back control, preset Aura Flap System and optional differential thrust.
- 2 X 40-size, 550kV motors and 60A ESCs for big power.
- (6) High-Precision Potenza DS34 servos.
- Light wing loading for easy handling.
- 4.5-9 minute flight times depending on battery choice and throttle management.
- Light Weight EPO foam that is durable and easy to repair.
- Ball-links on all control surfaces.
- Removable battery tray for easy battery installation.

INCLUDES

- Twin Otter 80E airframe with decals applied.
- Aura 8 Advanced Flight Control System (programmed and ready to use).
- (2) Potenza 40-3D 550kv Brushless Motor.
- (2) HobbyWing 60A ESC with 7A BEC.
- (6) Potenza DS34 High Performance Digital Servo.
- (1) Potenza DS15 High Performance Digital Servo.

REQUIRES





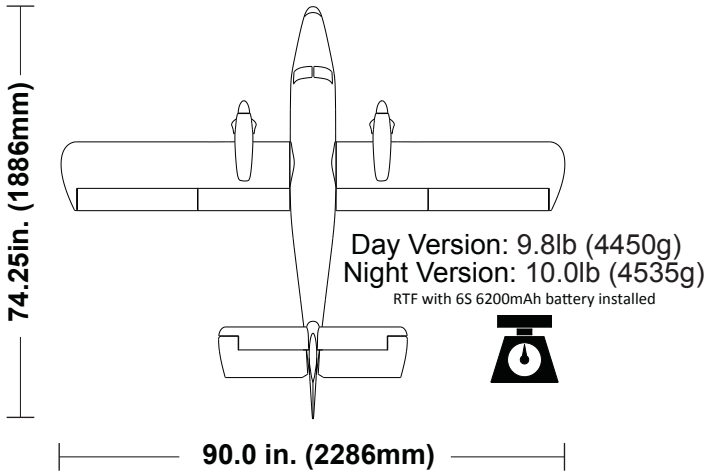



- Minimum 8 channel computer transmitter.
- 5200mAh - 6200mAh 6S 22.2V 35C+ LiPo (FPZB62006S40 recommended).
- Serial capable receiver to match your transmitter, e.g. Spektrum 4651T or Futaba R2001SB.
- 6S LiPo capable battery charger.

SPECIFICATIONS



Recommended battery – 6S 6200mAh 40C (FPZB62006S40) LiPo

COMPLETION ITEMS

INSTALLED!		Potenza 40-3D 550 KV Brushless Outrunner Motor (FPZM10403D)
INSTALLED!		HobbyWing 60A ESC (with BEC) (HW60AESC)
INSTALLED!		Potenza DS34 Digital Metal Gear Mini Servo (FPZDS34)
INSTALLED!		Aura 8 Advanced Flight Control System For Twin Otter (FPZAURA8ZZOTTER)
INCLUDED!		14 x 6 (x2) Wood Propeller, CW & CCW (FPMPF146EL, FPMPF146ER)
NEEDED TO COMPLETE		5200-6200mAh 6S 22.2V 35C+ LiPo (FPZB52006S40, FPZB62006S40)
NEEDED TO COMPLETE		8+ Channel Computer Transmitter
NEEDED TO COMPLETE		Serial-Capable Receiver (e.g. Spektrum 4651T, Futaba R2001SB)

OPTIONAL ITEMS

FPM507024	Twin Otter 80E: Float Set with Led Lights
FPZ507025	Twin Otter 80E: Wing Bag Set
FPZB52006S40	Potenza 6S 5200mAh 40C LiPo Battery
FPZB62006S40	Potenza 6S 6200mAh 40C LiPo Battery
FPZB5003S25	Potenza 3S 500mAh 25C LiPo Battery (night flight)
SPMXC2000	Spektrum Smart S2100 G2 AC Charger 2X100W
SPMXBC100	Spektrum XBC100 Smart Lipo Battery Checker
SPM4651T	DSMX SRXL2 Serial Telemetry Receiver
SPMR8200	Spektrum NX8 Transmitter Only
FUTT6K	Futaba T6K Transmitter with R3006SB Rx Mode 2
FUTR2001SB	Futaba R2001SB SFHSS S-Bus

REPLACEMENT PARTS LISTING

FPM5070A	Twin Otter 80E: Super PNP Flex Army Scheme Day
FPM5080A	Twin Otter 80E: Super PNP Flex Army Scheme Night
FPM507001	Twin Otter 80E: Fuselage
FPM507002L	Twin Otter 80E: Left Wing Panel
FPM507002R	Twin Otter 80E: Right Wing Panel
FPM507003	Twin Otter 80E: Vertical Fin
FPM507004	Twin Otter 80E: Horizontal Stabilizer set
FPM507005	Twin Otter 80E: Motor Cowling Set
FPM507006	Twin Otter 80E: Nose
FPM507007	Twin Otter 80E: Main Landing Gear Wire
FPM507008	Twin Otter 80E: Main Landing Gear Mount w/Cover
FPM507009	Twin Otter 80E: Landing Gear Foam Fairing Set
FPM507010	Twin Otter 80E: Nose Landing Gear Wire
FPM507011	Twin Otter 80E: Nose Wheel Steering Assembly
FPM507012	Twin Otter 80E: Aileron and Flap Wire Harness (2)
FPM507013	Twin Otter 80E: Hardware package
FPM507014	Twin Otter 80E: Pushrod Set Assembly
FPM507015	Twin Otter 80E: Interplane Wing Struts Set
FPM507016	Twin Otter 80E: Y Harness ESC EC3/EC5 w/extensions
FPM507017	Twin Otter 80E: Left Spinner (CCW)
FPM507018	Twin Otter 80E: Right Spinner (CW)
FPM507019	Main and Nose Wheel Set
FPM507020	Twin Otter 80E: C/F Tube Set
FPM507021	Twin Otter 80E: Hatch set
FPM507022	Twin Otter 80E: Steering Tray Plywood Part
FPM507023	Twin Otter 80E: Wing Servo PCV Board Set
FPM507024	Twin Otter 80E: Float Set With Led Lights
FPM507025	Twin Otter 80E: Decal set Flex Army Scheme
FPM508001	Twin Otter 80E: Fuselage with LED Lights
FPM508002L	Twin Otter 80E: Left Wing Panel w/LED Lights
FPM508003	Twin Otter 80E: Right Wing w/ LED Lights
FPM508004	Twin Otter 80E: Vertical fin w/LED Lights
FPM508005	Twin Otter 80E: Horizontal Stabilizer set
FPM508006	Twin Otter 80E: Nose w/LED Lights
HW60AESC	HobbyWing 60A ESC with BEC
FPMPF146EL	Flex Innovation Wood Prop 14x6 Left (CW)
FPMPF146ER	Flex Innovation Wood Prop 14x6 Right (CCW)
FPZM10403D	Potenza 40 3D 550Kv Brushless Electric Motor
FPZDS34	DS34 Digital MG Mini Servo
FPZDS15	DS15 Sub-Micro Servo
FPZM10203D1	Potenza 20-3D Bolt On Prop Adapter
FPZM10403DCCW	Potenza 40-3D Bolt On Prop Adapter Left Threaded
FPZM10203D2	Potenza 20-3D Aluminum Motor Mount
FPZM10403D3	Potenza 40-3D Motor Shaft
FPZAURA8ZZOTTER	Aura 8 Advanced Flight Control System For Twin Otter

SPECIAL LANGUAGE DEFINITIONS

The following terms are used throughout the product literature to indicate various levels of potential harm when operating this product:

- NOTICE:** Procedures, which if not properly followed, create a possibility of physical property damage AND a little or no possibility of injury.
- CAUTION:** Procedures, which if not properly followed, create the probability of physical property damage AND a possibility of serious injury.
- WARNING:** Procedures, which if not properly followed, create the probability of property damage, collateral damage, and serious injury OR create a high probability of serious injury.

WARNING

AGES 14+

This product is not intended for use by children under 14 years without direct adult supervision.

ATTENTION

Read the ENTIRE instruction manual to become familiar with the features of the product before operating. Failure to assemble or operate the product correctly can result in damage to the product, personal property, and cause serious or fatal injury.

All instructions, warranties and other collateral documents are subject to change at the sole discretion of Flex Innovations, LLC. For up-to-date product literature, please visit our website at www.flexinnovations.com and click on the Twin Otter 80E and Aura 8 product pages.

IMPORTANT INFORMATION REGARDING WARRANTY

Please read our Warranty and Liability Limitations section before building this product. If you as the Purchaser or user are not prepared to accept the liability associated with the use of this Product, you are advised to return this Product immediately, in new and unused condition, to the place of purchase.

SAFETY WARNINGS AND PRECAUTIONS

Protect yourself and others by following these basic safety guidelines.

1. This manual contains instructions for safety, operation and maintenance. It is essential to read and follow all the instructions and warnings in the manual, prior to assembly, setup or use, in order to operate correctly and avoid damage or serious injury.
2. This model is not a toy, rather it is a sophisticated hobby product and must be operated with caution and common sense. This product requires some basic mechanical ability. Failure to operate this product in a safe and responsible manner could result in injury or damage to the product or other property.
3. This model must be assembled according to these instructions. Do not alter or modify the model outside of these instructions provided by Flex Innovations, LLC, as doing so may render it unsafe and/or un-flyable. It is your responsibility to ensure the airworthiness of the model.
4. Inspect and check for the correct operation of the model and all its components before every flight.
5. If you are not an experienced pilot or have not flown a high-performance model before, it is recommended that you seek assistance from an experienced pilot in your R/C club for your first flights. If you're not a member of a club, the Academy of Model Aeronautics (AMA) has information about clubs in your area whose membership includes experienced pilots.
6. Keep the propeller area clear from such items such as loose clothing, jewelry, long hair, or tools as they can become entangled. Keep your hands and body parts away from the propeller as injury can occur.
7. Never fly in visible moisture or submerge the airplane or any of its electronic components in water. Permanent damage to electronic components may occur, or corrosion of components may lead to intermittent failures.

LOW VOLTAGE CUTOFF

LiPo batteries have a nominal (rated) voltage of 3.7v per cell, and fully charged, reach 4.2v per cell. Batteries are designed to be discharged below the nominal voltage, however, if they are discharged below 3.0v per cell, damage will occur and the pack will loose capacity. For best long term battery life, set a timer and land after a time that leaves approximately 15% of the battery's capacity remaining.

Low voltage cutoff is a feature that is built into the HobbyWing 60A ESCs that is designed to protect the connected battery from being discharged too far and causing permanent damage to the cells. Circuitry within the ESCs will automatically detect when the input voltage from the battery pack reaches below 3.0V per cell (average) and will remove power to the motor, but still deliver power to the servos so that a safe landing may be made. If the motor begins to lose power rapidly during flight, the LVC has sensed that the total voltage of the pack has dropped below 3.0V per cell average, and the airplane should be landed immediately.

BEFORE YOU BEGIN

NOTICE

If you have the night version of the Twin Otter 80E we recommend that you dry assemble the airframe and test all the lights before bonding anything permanently in place.

NOTICE

Do not use thread locker when attaching plastic parts, the parts will soften and fail.

NOTICE

The assembly of the Twin Otter 80E can be accomplished in less than one hour. Prior to assembling the airplane, it is advisable to charge your battery so that you are ready to begin setup upon completion of the assembly of your model.

BATTERY CHARGING GUIDELINES

WARNING

Follow all instructions provided by your battery and charger manufacturer. Failure to comply can result in fire.

We recommend the use of an advanced LiPo balancing charger, such as the Spektrum Smart S2100 G2 AC 2X100W Charger for your batteries to get the maximum performance and lifespan from them.

Our airplanes are designed around our Potenza LiPo batteries, and we recommend the Potenza 6S 6200mAh 40C LiPo in the Twin Otter 80E based on our extensive testing and development. These batteries feature an EC5 connector, so no soldering is required for use in your Twin Otter 80E.

All are available online at www.flexinnovations.com and your local Flex Innovations retailer.

MAIN LANDING GEAR INSTALLATION

Required Tools and Fasteners:

#1 Phillips Screwdriver
1.5mm Hex Driver
15 Minute Epoxy

(4) M3x12 Phillips Head Self-Tapping Screw
Blue Thread Locker

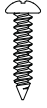

(QTY 4)

1. Insert the wire landing gear into the slot in the fuselage. Insert the landing gear mount cover and secure using four M3x12mm self tapping screws.
2. Mount the wheels to the end of the landing gear with a wheel collet on each side of each wheel. Use thread locker on all the set screws.
3. Glue the foam fairings to the landing gear wire leaving a 1-2mm gap to the fuselage to allow for landing gear wire movement. We recommend using 15 minute Epoxy.

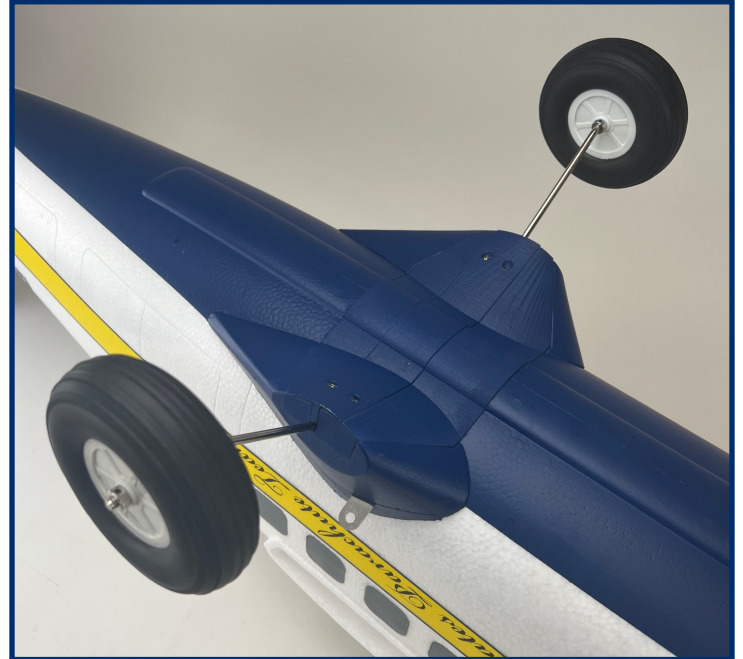

NOSE GEAR INSTALLATION

Required Tools and Fasteners:

1.5mm Hex Driver
15-Minute Epoxy
Mixing Cup
Thread Locker

#1 Phillips Screwdriver
Craft Sticks (for mixing epoxy)
Paper Towels

1. Find the nose gear steering servo tray and test fit it. Once you are happy with the fit make sure surfaces all are clean and then bond the tray in place with Epoxy adhesive. Fix it in place while the adhesive dries. Ensure that the adhesive is completely dry before proceeding.
2. Mount the wheel to the end of the nose gear strut with a wheel collet on each side of the wheel. Use thread locker on all the set screws.
3. Install the nose gear strut to the airplane with a wheel collet in the middle of each of the mounts. The steering arm goes on top of the assembly. Use thread locker on all set screws. View picture to the right for assembly details.
4. The servo arm should be pre-installed, ensure that the push-rod is crossed over as in the picture below. Connect the servo lead to the Y-harness on port S8 of the Aura (rudder). Once the radio is set up return to this assembly and ensure that the nose wheel is properly centered.



TAIL INSTALLATION

Required Tools and Fasteners:

30-Minute Epoxy
Craft Sticks (for mixing epoxy)
Mixing Cup
Low-tack Painters tape

220 Grit Sandpaper
Paper Towels
Isopropyl Alcohol

The tail assembly uses the short carbon fiber rod for reinforcement.

1. Dry fit the tail assembly and reinforcement rod to the fuselage. If you have the night version test the lights to ensure that they work before bonding anything permanently.
2. Once everything fits correctly, remove the carbon fiber rod and lightly scuff it with 220 grit sandpaper to aid in adhesion. Clean all surfaces with Isopropyl alcohol before bonding.
3. If you have the night version first connect the LEDs. Bond the tail assembly to the fuselage using 30-minute epoxy. Ensure that you get adhesive on all the mating surfaces as well as both ends of the carbon fiber rod.
4. Insert the horizontal stab tube and the wing tube into the airplane, ensure that they are parallel before taping the tail section to the fuselage, this step is critical or the airplane will not end up straight.
5. Tape the assembly in place with low-tack painters tape while the adhesive dries.

Note: Do not apply tape directly to any painted part as this will strip the paint off the part, place the tape only on the white areas.



HORIZONTAL STABILIZER INSTALLATION

Required Tools and Fasteners: #1 Phillips Screwdriver

(4) M3x8 Phillips Head Self-Tapping Screw



1. Insert and roughly center the carbon fiber horizontal stabilizer tube in the fuselage.
2. Insert both halves of the horizontal stabilizer onto the tube. Ensure that the control horn faces the bottom of the fuselage and that the elevator jointer tabs line up properly.
3. If you have the night version, connect the LED power connectors.
4. Once both halves of the horizontal stabilizer are seated in place, secure them using four M3x8mm self tapping screws.

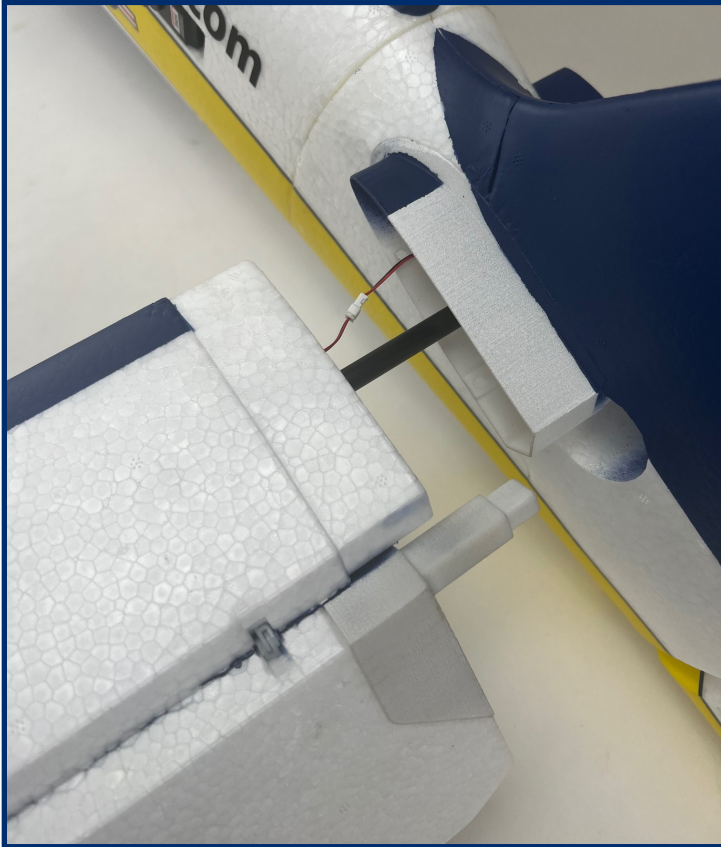

MOTOR INSTALLATION

Required Tools and Fasteners:

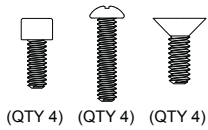

Motor Assembly
Prop Adapter Assembly
(4) M3x10 Socket Head Cap Screw
(4) M3x22 Phillips Button Head Screw

(4) M4x8 Phillips Flat Head Screw
2.5mm Hex Driver
#2 Phillips Screwdriver
Blue Thread Lock

1. Install the x-braces on the back of the motors using four M4x6mm flat head screws and thread locker.
2. Install the prop adapters on the front of the motors using the provided socket head hex screws and thread locker.
3. Mount the motors to the nacelles using four M3x22mm button head screws and thread locker. Note that the prop adapters are threaded for the appropriate propeller rotation. When viewed from the rear of the airplane, the black prop adapter (normal or right handed thread) is used on the right wing (CW) and the silver prop adapter (reverse or left handed thread) is used on the left wing (CCW).
4. Temporarily remove the ESC covers and connect the the three motor leads to the ESC leads inside the nacelles (when you test the motors, if they spins in the wrong direction you can reverse the direction of rotation by swapping any two leads).
5. **Note: Do NOT install the motor cowlings or the propellers at this point, these will be installed after radio setup and testing is complete.**

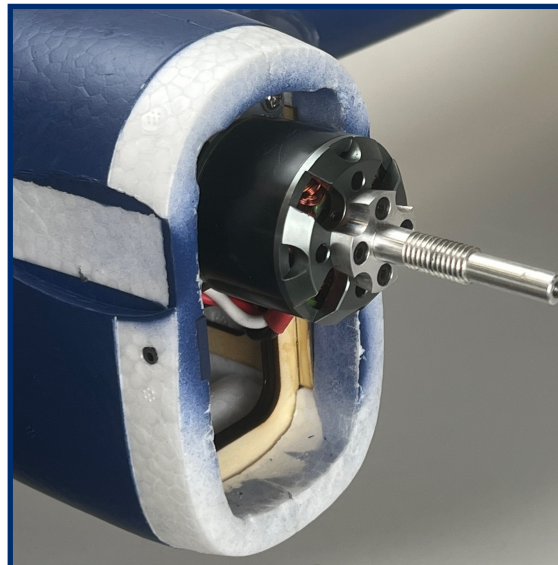
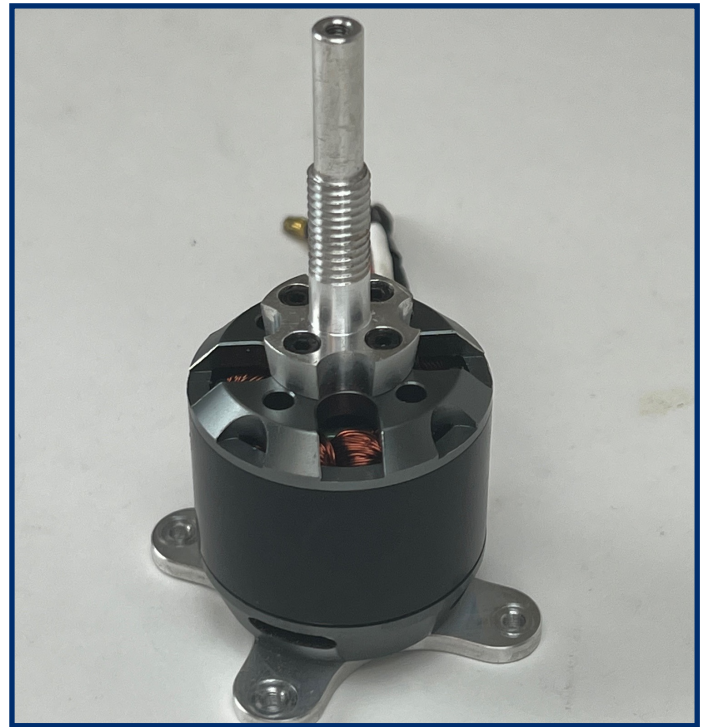
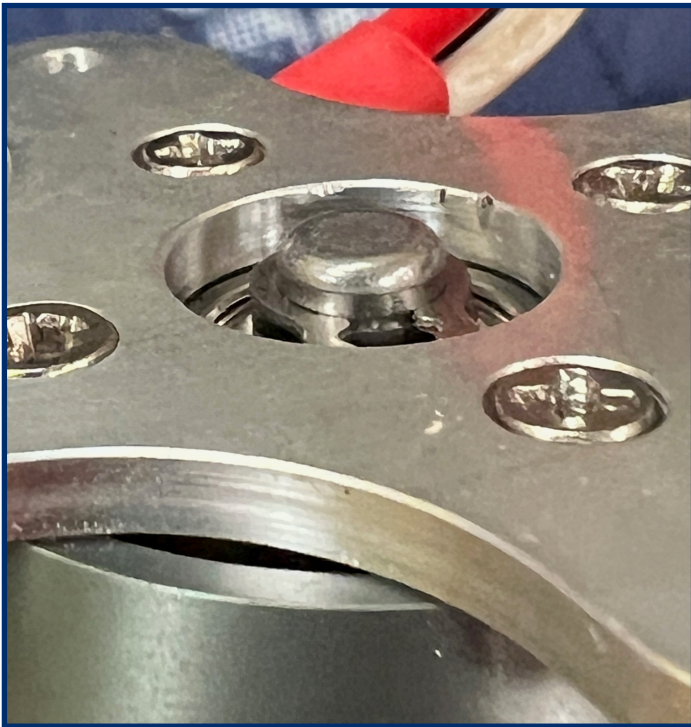

MAIN WING INSTALLATION

Required Tools and Fasteners:

(4) M4x18 Thumb Machine Screw
Blue Thread Lock

#2 Phillips Screwdriver

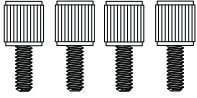

WARNING

REMOVE THE AILERON AND FLAP SERVO ARM RETAINING SCREWS (NOT THE MOUNTING SCREWS) AND APPLY BLUE THREAD LOCK TO THE SCREWS. RE-INSTALL THE SCREWS AND TIGHTEN FULLY. FAILURE TO DO SO MAY RESULT IN A CRASH

1. Install and secure a wing strut on each one of the wing nacelles using a pin keeper. Do not fly the Twin Otter 80E without the wing struts, they are a critical structural component that is required due to the motors and nacelles being on the wings.
2. Remove the hatch from the fuselage.
3. Insert and roughly center the carbon fiber wing tube in the fuselage.
4. Slide the left and right wing panels onto the tube. Ensure the servos orient towards the bottom of the fuselage.
5. Connect the single wing connector from each wing panel to the provided wing harnesses and run the servo wires through the corresponding opening into the fuselage.
6. Run the motor power lead (with the EC3 connector) into the fuselage through the corresponding opening in the fuselage.
7. If you have the night version, run the LED power connectors into the fuselage through the corresponding openings in the fuselage.
8. Seat the wings completely in the wing saddles and secure the wings using the thumb screws through the aluminum tabs. Since the Twin Otter 80E has the motors and nacelles on the wings, and as such carry more weight on the wings, it is important that the wings are secure. For that reason tighten the wing screws using a Phillips screwdriver before each flight.

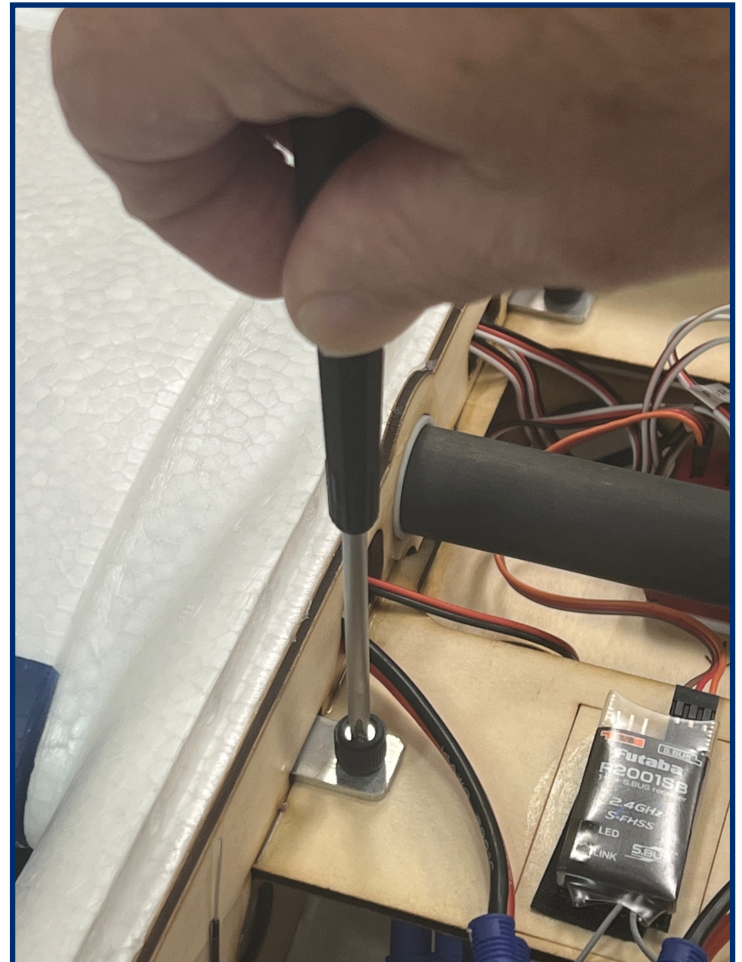
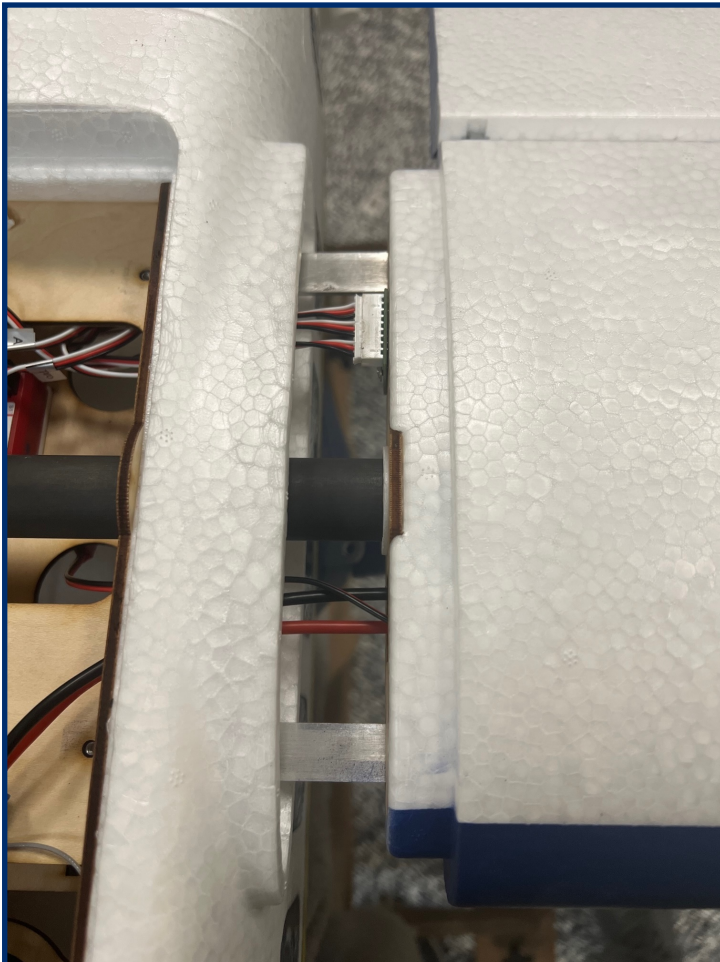

MAIN WING INSTALLATION (CONTINUED)

9. Connect the wing harness servo wires to the Aura as specified in the table on page 14 of this guide.
10. Connect each power lead to one end of the provided power lead Y-harness (2 EC3 connectors and 1 EC5 connector).
11. If you have the night version, connect the LED power connectors to the light controller. The two spare leads are used by the optional night floats.
12. Fasten the wing struts to the fuselage using the retaining pins and pin keepers.

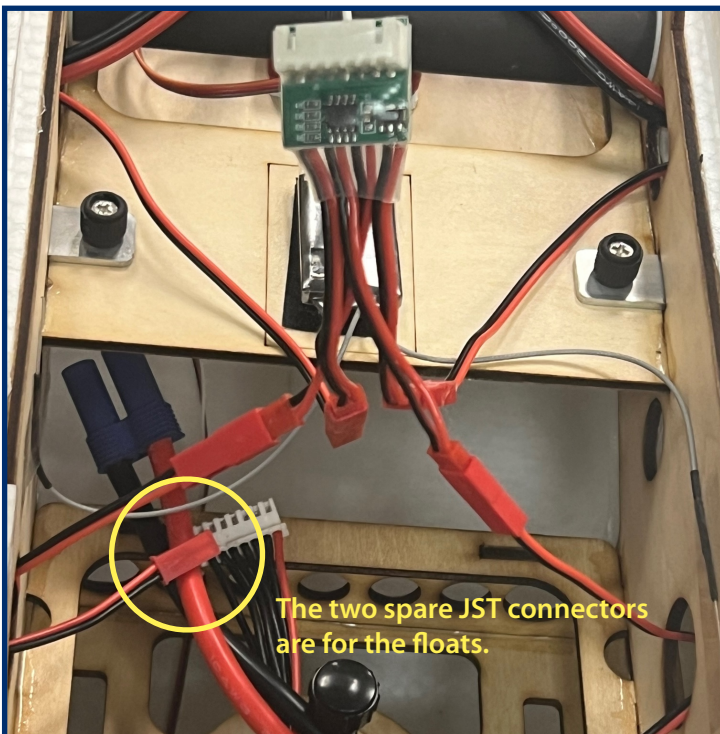
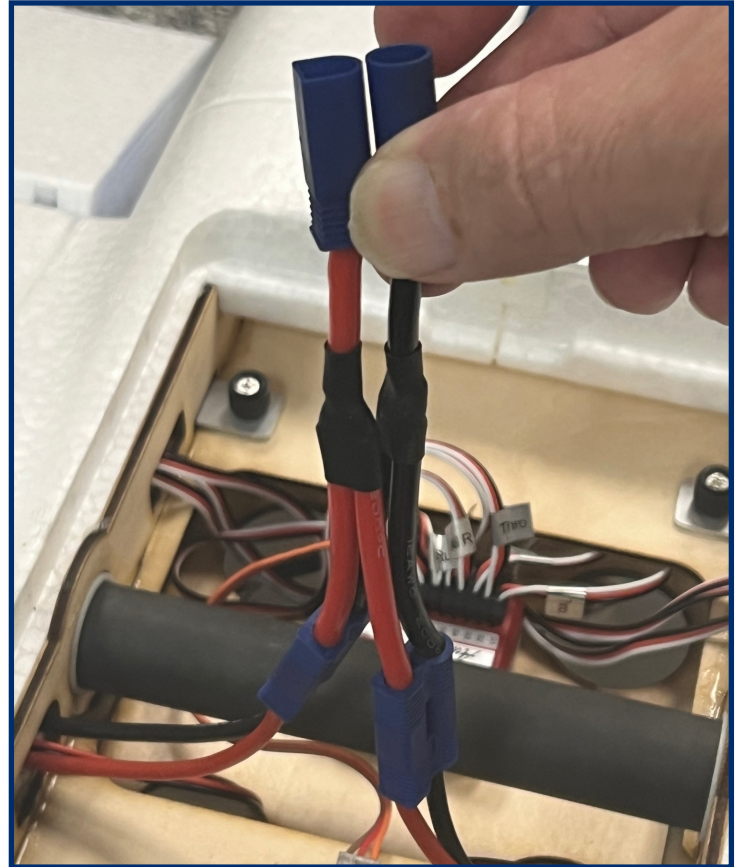
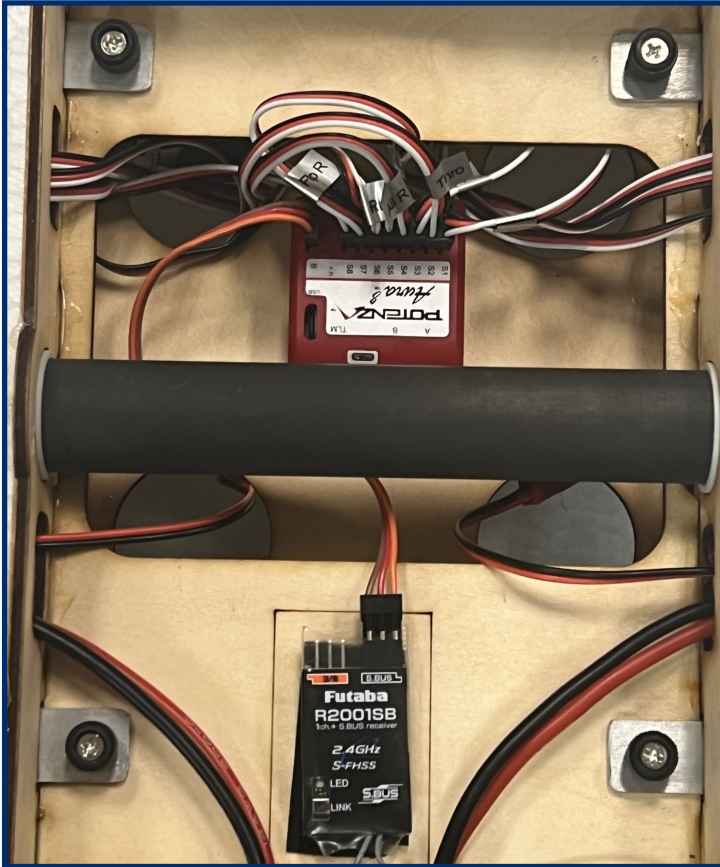

NIGHT TWIN OTTER 80E LED CONNECTIONS

If you have purchased the Night version of the Twin Otter 80E, this page will cover all LED light connections. If you did not purchase the night version, skip ahead to the next page.

NOTICE

If you have the night version of the Twin Otter 80E we recommend that you dry assemble the airframe and test all the lights before bonding anything permanently in place.

1. The first connection for the LED lights is under the carbon tube in the tail junction. This connection is made once before the tail is bonded in place.
2. There is a connection for each horizontal stabilizer half. Connect each one of these connectors the horizontal stab half while installing them.
3. There is a connection for each wing panel and a connection for each float coming out of the wing. While installing the wings route these connectors into the fuselage through the opening provided for them. Connect each one of the two power connectors to the two unused leads in the LED controller.
4. The nose cone has LED lights, connect these to the LED wire that is routed to the nose of the plane.
5. If using the floats with lights, connect each connector for the float set to the spare leads coming into the fuselage from the wings. You will need to cut a hole in the bottom of the fuselage to route the LED wires coming from the floats. For details on where to cut this hole refer to the installation manual for the Twin Otter floats. Secure the wires to the strut and fuselage using water proof tape.

CONNECTING A BATTERY TO THE LED CONTROLLER

The LEDs on your aircraft are switchable via the transmitter, and are designed to be powered by 12 volts (3S LiPo) through the 6S JST-XH balance tab on the LED controller. **By default, the LED controller is left unplugged. If the servo lead of the LED controller is not plugged into the Aura or a receiver, the LED controller will default in the ON position when powered, allowing the Night Version to be flown at night with a basic 8-channel transmitter or receiver.**

IN ORDER TO CONTROL THE LEDS FROM THE TRANSMITTER, YOU MUST USE A STANDARD RECEIVER THAT IS CAPABLE OF 9+ CHANNELS, AND KEEPS THE SERVO PORTS ACTIVE WHEN USING A DIGITAL DATA STREAM (like S.Bus, SRXL2 etc.).

! WARNING

You MUST use an independent 3S LiPo battery to power the LEDs in the Twin Otter 80E. Failure to do so can damage your flight batteries. We recommend the use of the Potenza 3S 2200mAh 45C LiPo (FPZB22003S45) or the Potenza 3S 500mAh 25C LiPo (FPZB5003S25).

! WARNING

Do not leave the battery plugged into the LED controller for extended periods of time. Doing so can damage the battery. Average current draw for the lighting system is 2.2A/h

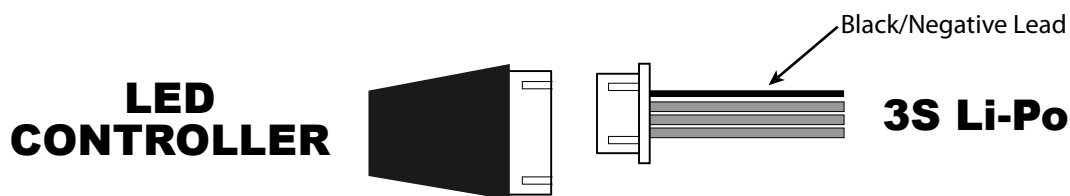

AURA 8 AFCS

The Aura 8 AFCS (Advanced Flight Control System) comes programmed and pre-installed in your Twin Otter 80E, making setup a breeze. This highly-refined 3-axis gyro makes the Twin Otter 80E fly like it is a larger aircraft and in less wind. Thanks to the Aura's advanced implementation, it not only enhances the flying experience, but it never interferes with the pilot's control.

The Aura 8 AFCS comes configured with Flight Modes (dual rates, expos and gyro settings) set by the Flex Innovations team, and offers a great starting point for most pilots. **Since these are already configured for you in the Aura, there is no need to set up dual rates, expos or flaps in your transmitter.** Simply follow the Transmitter Configuration Guide in this manual for complete details on the transmitter programming required for the Twin Otter 80E and Aura 8 AFCS.

Visit wiki.flexinnovations.com/wiki/Aura for the latest Aura-related product information and updates.

The following shows the pre-configured Aura flight modes in the Twin Otter 80E.

Twin Otter 80E Aura Profile

Flight Mode 1: Sport (Gyro Off)

- For safety only, do not fly in this mode unless you suspect that the gyro is behaving incorrectly or erratically.
- Rates and Expos are tuned for general flying.
- Live Wing (flaps coupled to ailerons) is inactive.
- Gyro is set to off.

Flight Mode 2: Sport (Gyro On)

- For sport flying and for all taxiing on the ground.
- Rates and expos are tuned for sport flying.
- Live Wing is active.
- Gyro is set to low.

Flight Mode 3: Advanced (Gyro On)

- For advanced aerobatic flight, note: do not taxi in this mode.
- Rates are highest and expos are tuned for 3D flight.
- Live Wing is active.
- Differential thrust is used (if enabled via switch).
- Gyro is set to moderately high.

In all flight modes, the flaps function with the operation of CH6 (Aux 1) on the transmitter.

NOTE - Rudder stick movement will also move the ailerons and elevator. Flap (CH6) movement will also move the elevator. This is NORMAL and is the pre-programmed mixing.

Each of the modes has been tuned by our team to offer a solid start. Because tastes in control feel are unique, if changes in rate, expo or gains are needed, adjustments can be made through Aura. We highly recommend that you do not change any of these in your transmitter.

The Aura 8 AFCS Profile for the Twin Otter 80E can be enhanced with optional features without the need of a computer. For further details, please see the section of this manual titled **Twin Otter 80E Aura Optional Features Configuration** on page 25.

AURA 8 SERVO CONNECTIONS

DEFAULT AURA CONNECTIONS

- S1 – Left Throttle**
- S2 – Right Throttle**
- S3 – Left Aileron**
- S4 – Right Aileron**
- S5 – Elevator**
- S6 – Rudder**
- S7 – Left Flap**
- S8 – Right Flap**

Port B – Serial Receiver Input

Mini Port A&B – Remote Receiver Inputs

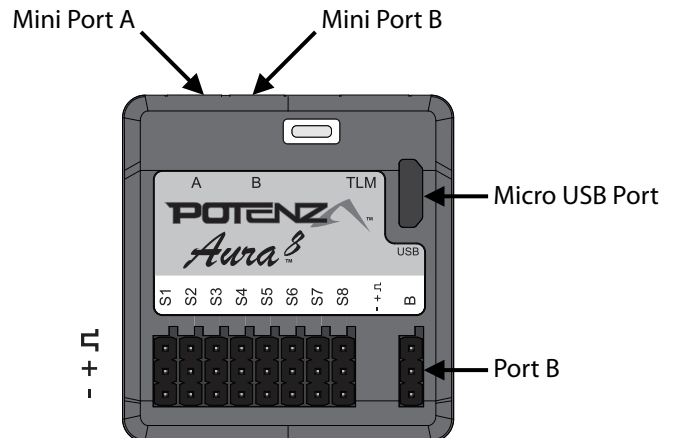

TRANSMITTER SETUP

The included Aura 8 is designed to work seamlessly with all popular transmitter and receiver brands, however, transmitter setup is significantly different than when setting up a model without Aura. Follow these steps:

1. Start with a new model memory in your transmitter. Reset it to be certain it is set to defaults.
2. Adjust your transmitter settings according to the Transmitter Configuration Guide below.
3. **Make ONLY the changes shown in the Transmitter Configuration Guide.** No other changes are required.

Transmitter Configuration Guide

	Spektrum, Futaba, JR ¹ & Graupner	FrSky	Jeti (EX-Bus)
Wing/Tail Type	1 Aileron, 1 Elevator, 1 Rudder	1 Aileron, 1 Elevator, 1 Rudder	1 Aileron, 1 Elevator, 1 Rudder
End Points (Travel Adjust or ATV)	Ail/Ele/Rud – 125%	Ail/Ele/Rud – 100%	Aileron/Ele/Rud – 100%
	Thro/CH5/CH6 – 100%	Thro/CH5/CH6 – 84%	Thro/CH5/CH6 – 80%
Reversing ²	Not Allowed		
Sub-Trim	Verify at Zero, NOT ALLOWED		
Trim Levers	Verify at Zero		
CH5 (Gear) – Flight Mode	Assign to a 3 Position Switch		
CH6 (Aux 1) – Flaps	Assign to a 3 Position Switch (Do NOT use Transmitter Flap System)		
CH7 (Aux 2) – Differential Thrust On/Off	Assign to a 2 Position Switch (We recommend that you use the same switch as you use for throttle cut)		
CH8 (Aux 3) – Crow ³	Assign to a 2 Position Switch		
First Flight Timer ⁴	For your first flight, set to 4:30		

- 1 JR customers should use JR XBUS Mode A, and follow the chart above. This is the preferred JR DMSS connection to Aura.
- 2 If you are using a Futaba transmitter, please note that some Futaba transmitters have the throttle set to reversed by default. We recommend that you leave the reversing set to the defaults and reverse it if needed after testing. **NOTE: do all throttle testing with the props removed!**
- 3 The default Aura program has Crow disabled, please see the section of this manual titled **Twin Otter 80E Aura Optional Features Configuration** on page 25 to enable Crow.
- 4 This time is a safe starting point for most pilots. This aircraft can typically fly anywhere between 4.5 to 9 minutes (with 6S 6200mAh LiPo), depending on an individual's flying style.

FOR CUSTOMERS USING TRANSMITTERS OTHER THAN WHAT IS LISTED IN THE CHART ABOVE, PLEASE VISIT OUR WIKI PAGE FOR INSTRUCTIONS SPECIFIC TO YOUR TRANSMITTER AND RECEIVER BRAND

HITEC – wiki.flexinnovations.com/wiki/Aura/HitecSbusUse

RECEIVER INSTALLATION

Choosing a Receiver

Aura will auto-detect modern serial receiver connections. For use in the Twin Otter 80E, only a serial receiver connection or two Spektrum Remote Receivers can be used. Below are a few examples of serial receivers that can be used with the Aura 8. This is not a complete list of compatible receivers, rather a short list to assist in your receiver selection.

Spektrum Remote Receivers – SPM9745 (2 Required)

Spektrum SRXL – SPMAR6610T, SPMAR8020T, SPMAR10100T

Spektrum SRXL2 – SPM4651T, SPM4650

Futaba S.Bus – Futaba R7008SB, R2001SB, R6202SBW

Hitec S.Bus – Optima SL, Maxima SL

FrSky S.Bus – RX4R, RX6R

Graupner HoTT (Sum D of 8) – GR12L, GR16L

JR XBus (Mode A & Mode B) – RG012BX, RG613BX, RG821BX

Jeti EX-Bus – REX10, R9 EX, REX6

CONNECTING YOUR RECEIVER TO AURA

Serial Receivers

If using a standard serial receiver, connect the provided male to male cable to your receiver's serial port. Connect the other end of the cable to Aura Port B noting proper polarity.

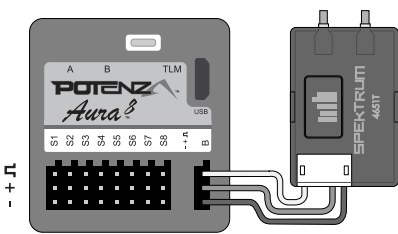

Note: SRXL2 receivers like the 4651T require the use of a different cable to connect to Aura. The cable is included with the receiver when it is purchased directly from Flex Innovations. You can also purchase the cable itself at flexinnovations.com (FPZA1039). Other receivers like the AR6610T provide a standard servo port for the SRXL2 signal.

Note: If you are using Futaba S.Bus, be sure to use the proper S.Bus port in your receiver. DO NOT use the S.Bus2 port, as it is not supported for use with the Aura 8. Refer to your manufacturer's instructions for proper S.Bus use.

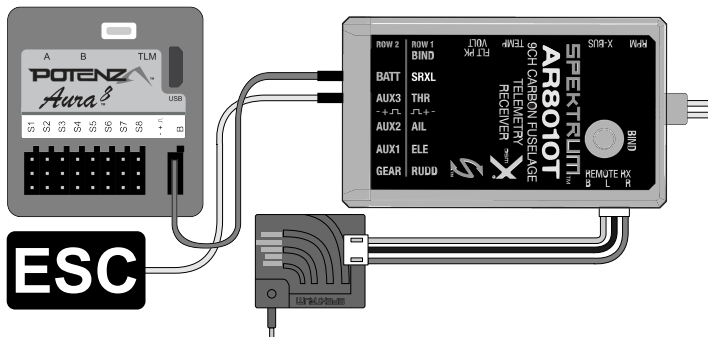
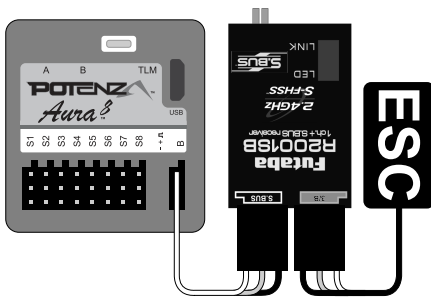

Note: When using Spektrum SRXL or SRXL2 to connect to the Aura, always connect the remote receivers to the Spektrum receiver, NOT to the Aura.

Binding Your Receiver

Bind your receiver to your transmitter per your receiver and transmitter manufacturer's instructions.

Aura 8 Auto-Detect

Note: Before powering up the airplane for the first time ensure that there is not trim or sub-trim on any of your main channels (aileron, elevator or rudder) as this may lead the Aura 8 Auto-Detect feature to fail or work improperly. Once your receiver is bound, powered, and connected to the Aura, the Aura will begin the Auto-Detect process to learn what type of receiver you are using and set itself up for that specific system. Auto-Detect is indicated by a series of sweeping LEDs of various colors. After Auto-Detect is completed, verify that Aura is on and receiving data from your receiver by looking at the LEDs on the Aura.

Ready-To-Fly:

Solid Orange LED: Aura On and Calibrated

Solid Green LED: Aura receiving Valid receiver data



Spektrum Remote Receivers

If using two Spektrum Remote Receivers, connect them to Aura Mini Port A and Mini Port B using the cable provided with your receivers.

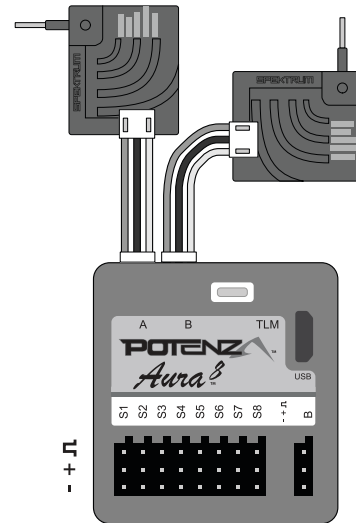

Binding Your DSMX Remote Receivers

1. With the transmitter and aircraft powered OFF, place a bind plug into Aura Port S8.
2. Power on the aircraft. Your remote receivers should flash rapidly, indicating it is in bind mode.
3. Bind your transmitter to the remote receivers per your transmitter manufacturer's instructions. This is typically done by pressing and holding the bind button on your Spektrum transmitter while powering it on.
4. Verify the receivers are bound by looking at the LED on the Remote Receivers. This is typically indicated by a solid orange LED on Spektrum Remote Receivers.
5. Remove the bind plug from Aura Port S8.

Possible Errors:

Flashing Orange LED: Aura Moved During Power Up

No Green LED: Aura NOT receiving receiver data



RUDDER AND ELEVATOR LINKAGE INSTALLATION

Required Tools and Fasteners:

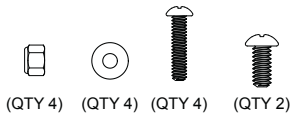

Elevator and Rudder Pushrod Assemblies
(4) M2x10 Phillips Head Machine Screw
(4) M2 Flat Washer
(4) M2 Lock Nut
(2) M3x6 Phillips Head Machine Screw

#2 Phillips Screwdriver
#0 Phillips Screwdriver
Needle-Nosed Pliers (or Hemostats)
Blue Thread Lock

1. Locate the rudder and elevator pushrod assemblies, as well as the servo arms and hardware. Note the shorter pushrod is for the elevator and the longer one is for the rudder.
2. Power on your transmitter, and power on the airplane. Once the Aura 8 has initialized and you can verify that the servos are operating properly. Set the flight mode to FM1 before making any adjustments to servo arm positions or to pushrod lengths. This will disable the Gyro and ensure that the control surfaces are centered and don't have any motion if the airplane is accidentally moved.
3. With the aircraft still powered on, install the rudder and elevator servo arms perpendicular to the servo case, being sure to orient the servo arm towards the top of the fuselage for the elevator and towards the bottom of the fuselage for the rudder (as shown below). Apply blue thread lock to the M3x6 Phillips head machine screw, and secure the servo arm in place with a #2 Phillips screwdriver.

WARNING

DUE TO VARIANCES IN PRODUCTION AND THE LARGE CONTROL SURFACE THROWS ON THIS AIRCRAFT, PROPER SERVO CENTERING AND TRAVEL ADJUSTMENT IS CRITICAL TO PREVENT SERVO OVER TRAVEL AND FAILURE. IF THE SERVO ARMS ON YOUR AIRCRAFT DO NOT SIT PERPENDICULAR TO THE SERVO CASE, YOU MUST USE THE AURA CONFIG TOOL TO ADJUST THE SUB-TRIM AND OUTPUT SCALE VALUES TO PREVENT OVER TRAVEL OF THE SERVOS.

To download the Aura Config Tool, please visit: <https://www.flexinnovations.com/aura-config-tool-install/>

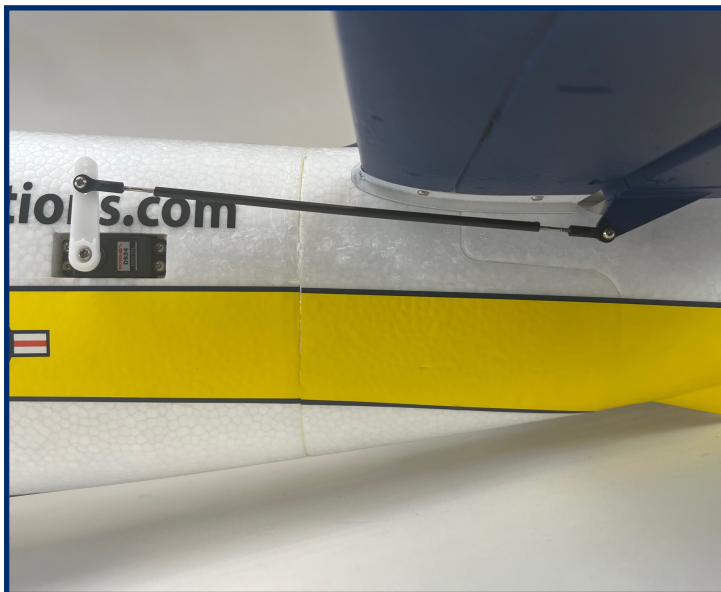

RUDDER AND ELEVATOR LINKAGE INSTALLATION (CONTINUED)



WARNING

Note: Do not use thread locker on the bolts holding the push rods to the servo arms or the control horns!
Using thread locker will weaken the plastic, void your warranty, and cause your airplane to crash!

- Use a #0 Phillips screwdriver, M2x10 machine screw, M2 washer and M2 lock nut to secure the linkage to the control horn and servo arm. Use the diagrams below for proper control horn and servo arm linkage locations. The sequence of the hardware components is as follows:
 - M2x10 Machine Screw
 - M2 Washer
 - Ball Link
 - Servo Arm or Control Horn
 - M2 Lock Nut
- Repeat the process for the other control linkage.

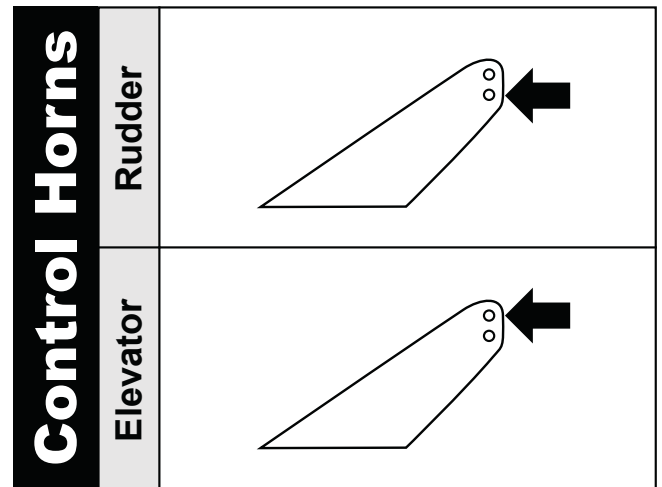
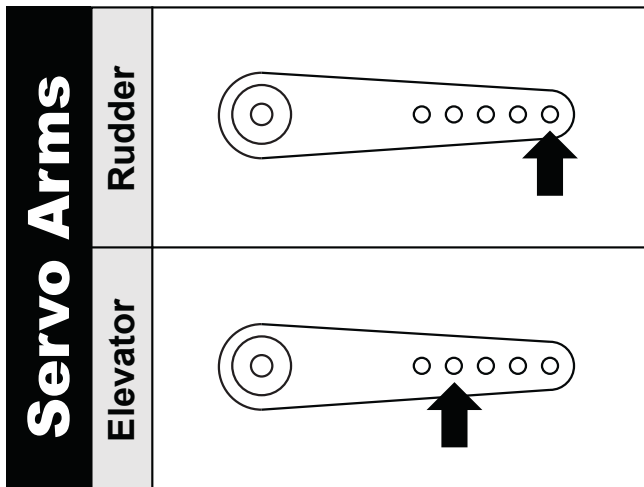

Take this this moment to check and finalize the position of the servo arms and pushrod lengths on your ailerons, flaps and nose gear steering. Also ensure that the motors are spinning in the correct direction, left motor is CCW and right motor is CW when viewed from the tail of the airplane (as shown below) swap any 2 motor → ESC wires to reverse motor rotation.

Make any final control surface adjustments as necessary either mechanically or in the Aura configuration, do not use trim or sub-trim on the radio.

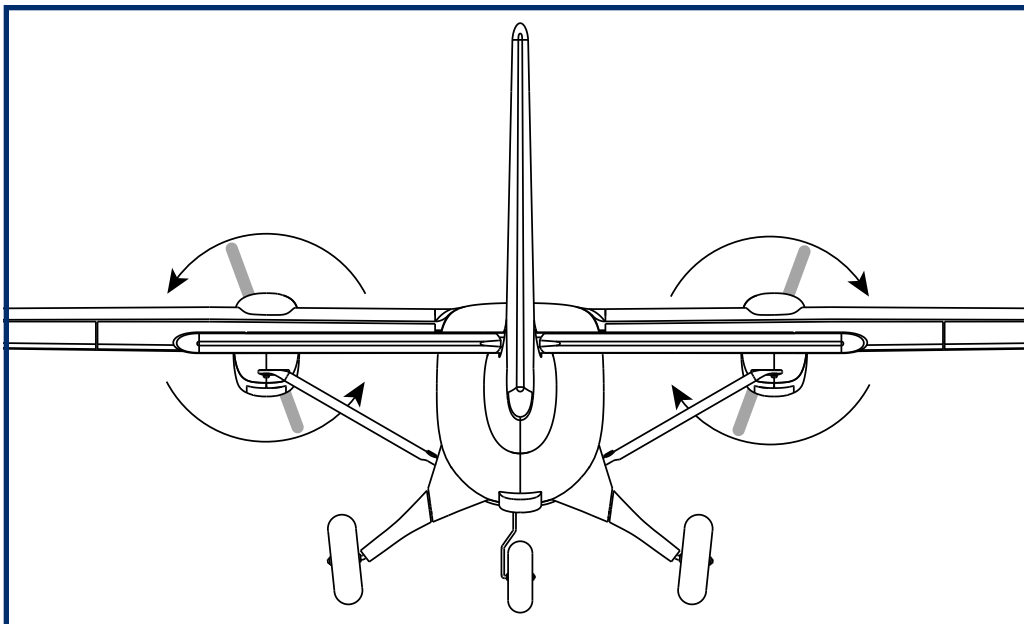

CONNECTING BATTERY/ARMING ESC

Observe the following procedures to safely power up your model after it has been bound. **Ensure propellers are removed unless this sequence is followed to power up before flight.**

1. Turn on the transmitter. **Lower the throttle stick AND throttle trim** to their lowest settings. Be sure to wait for your transmitter to indicate it the radio signal is being broadcast before proceeding.

If a battery is connected to the ESCs with the throttle fully open on the transmitter, the ESCs will enter programming mode. If this occurs, simply disconnect the battery, lower the throttle and reconnect the battery.

2. Ensure the aileron, elevator and rudder gimbals are centered.
3. With the airplane on a solid surface, connect the battery to the ESCs and wait. The ESCs will make the motors emit a series of audible tones during their initialization process.
4. The ESCs will make the motors emit a short, final tone sequence indicating that the ESCs are now armed and that the motors will spin in response to throttle stick movement.

WARNING

When making adjustments to linkages, transmitter settings, or the Aura 8 flight control system, remove the propellers to guard against accidental spool up.

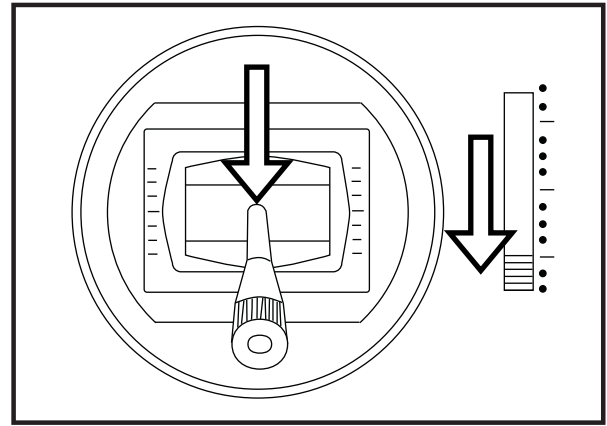

CAUTION

Always connect the battery when the throttle stick and throttle trim are in the idle/cut-off position.

WARNING

Hold aircraft securely when connecting the battery before flight. Always ensure that the propellers are clear of any and all objects as they may become entangled.

ESC THROTTLE CALIBRATION

In order to map the full range of the ESCs output to your throttle stick motion you will have to preform an ESC throttle calibration. Both ESCs will calibrate simultaneously so you only need to calibrate once. **NOTE: Execute ESC throttle calibration with the propellers and spinners removed.**

1. Power on your transmitter, DISABLE any throttle hold or throttle kill switches, **completely lower the throttle trim** and set the stick to full throttle.
2. Connect the flight pack to your Twin Otter 80E.
3. Listen for the tones coming from the ESCs through the motors, about 2 seconds after RF is engaged you should hear two tones.
4. Pull your throttle stick back to idle.
5. Listen for the ESC arming tones from the motor.
6. Unplug the flight battery to complete calibration.

The ESC throttle range has now been properly calibrated, and is stored in the ESC's memory until it is calibrated again. You can repeat this process as many times as necessary.

CAUTION

Note: After throttle calibration is complete it is necessary to reset the failsafe on your receiver (see your radio documentation, this may require a re-bind).

CONTROL DIRECTION TEST

Refer to the chart below to determine the proper control surface directions, test these in Flight Mode 3. To test differential thrust, **PROPELLERS MUST BE REMOVED** and channel 7 must be active (typically throttle hold off).

If controls are reversed, DO NOT REVERSE CONTROLS IN YOUR TRANSMITTER OR IN THE AURA CONFIG TOOL. Email us at support@flexinnovations.com for corrective action. Note that BOTH the Transmitter Control Direction Test AND the Flight Controller Sensor Direction Test MUST BE PASSED! IF EITHER ONE DOES NOT PASS, DO NOT FLY!

NOTE: There is pre-configured rudder to aileron and rudder to elevator mixing programmed into the Aura. Simultaneous movement of these control surfaces with rudder input is intentional and completely **NORMAL**.

Additionally: Aura has a built-in flap system that moves the flaps at a slower speed. There is also flap to elevator mixing configured in the Aura Flap System. This speed and mixing is intentional and completely **NORMAL**.

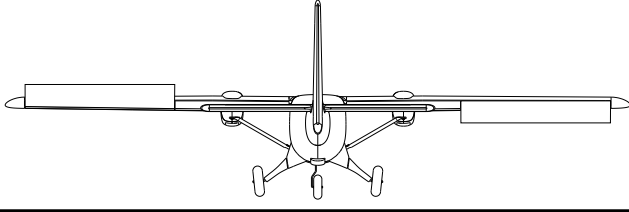
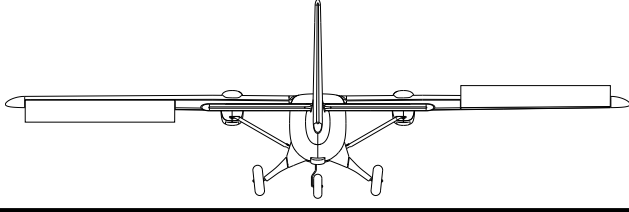
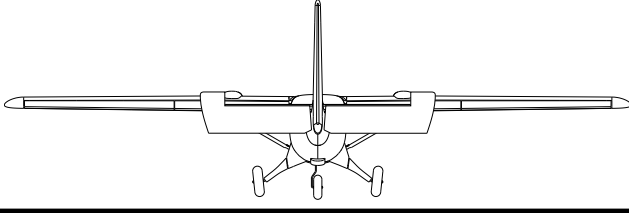
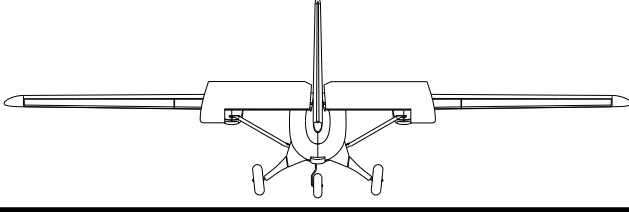
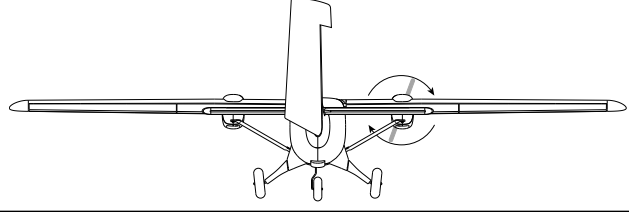
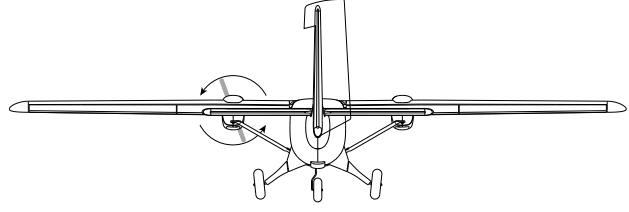
	Transmitter Command	Proper Control Surface Deflection
AILERON	Stick Left	
	Stick Right	
ELEVATOR	Stick Forward	
	Stick Aft	
RUDDER	Stick Left	
	Stick Right	

AURA SENSOR DIRECTION TEST

Perform a test of the gyro system to verify the corrections made for a given movement are correct. **If any of the tests do not result in the correct reaction from the airplane's gyro system, DO NOT FLY THE AIRPLANE, and contact us via email at support@flexinnovations.com**

The flight control system activates with RF broadcast. Perform these tests in Flight Mode 3 (higher gain) for better visibility and then in Flight Mode 2. Gyro is disabled in Flight Mode 1 so there will be no motion when performing this test. Control surface deflections are exaggerated in the pictures below for clarity. Please note that the control surfaces will move **ONLY** while the aircraft is being **ROTATED**. To test differential thrust, **PROPELLERS MUST BE REMOVED** and channel 7 must be active (typically throttle hold off).

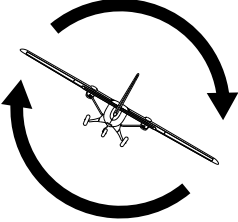
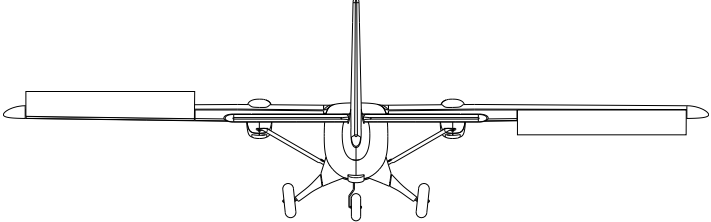
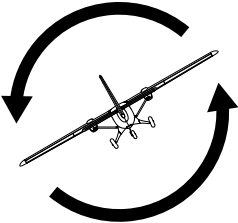
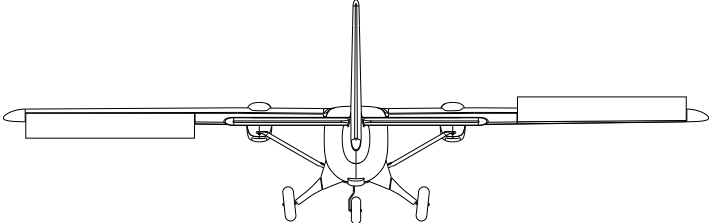
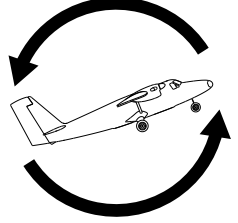
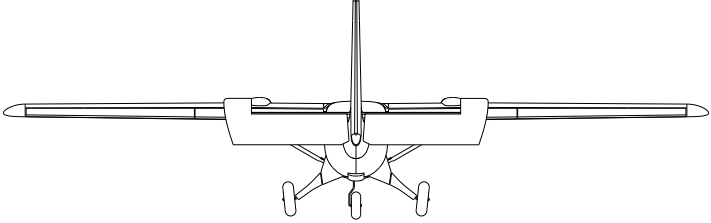
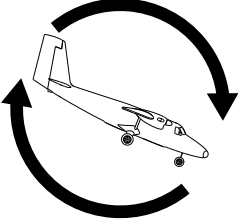
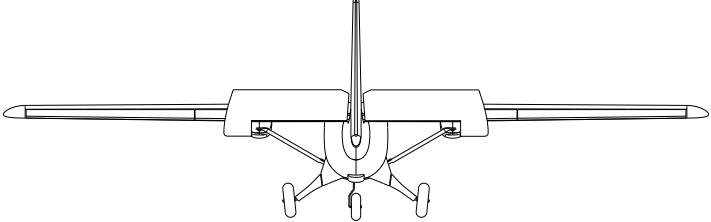
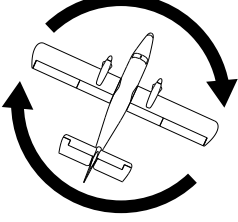
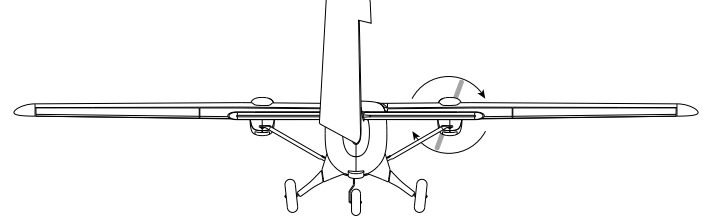
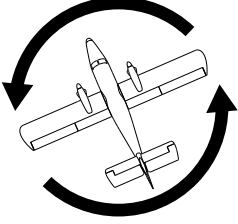
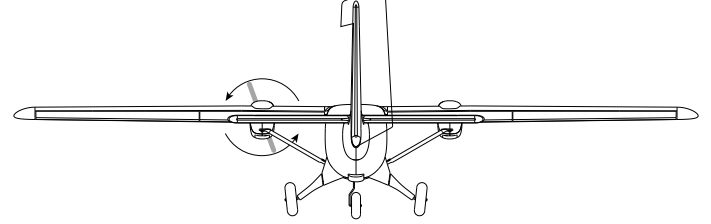
	Aircraft Movement	Proper Control Surface Deflection
AILERON		
		
ELEVATOR		
		
RUDDER		
		

NOSE CONE, COWLING, PROPELLER AND SPINNER INSTALLATION

Required Tools and Fasteners:

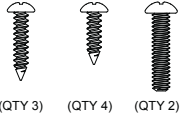

- (3) M2x7 Phillips Self Tapping Screw
- (4) M2x13 Phillips Self Tapping Screw
- (2) M3x10 Phillips Button Head Screw

- M8 Nut & Washer for Propeller Adapter
- #1 Phillips Screwdriver

1. Install the nose cone using three M2X7mm self tapping screws, if you have the night version connect the LED lead first.
2. Install the cowlings to the motor nacelles using two M2X13mm self tapping screws. Glue the exhaust to each side of the nacelles using CA or Epoxy.
3. Install the propellers to the motors using the provided washer and nut, note that they are labeled L and R, defined as viewed from the rear of the airplane.
4. Install the spinners to the prop adapters using the provided M3X10mm screw (don't use thread locker). There is a left and a right spinner, use the shape of the prop to determine which side each spinner should be installed on.

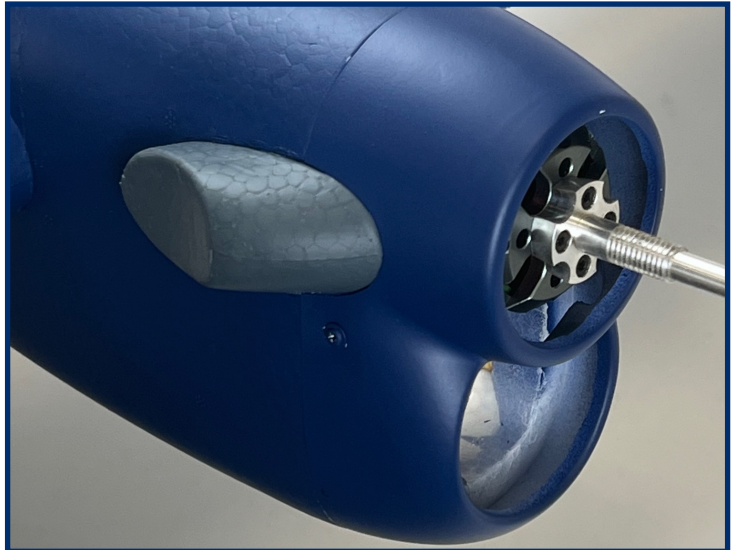
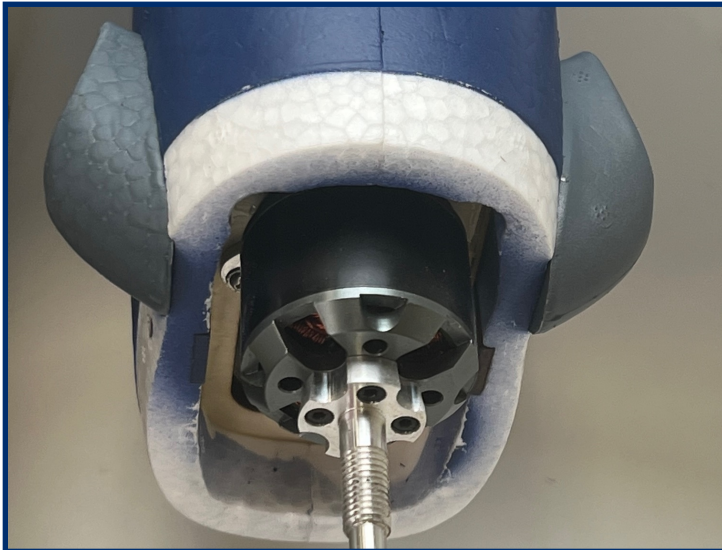
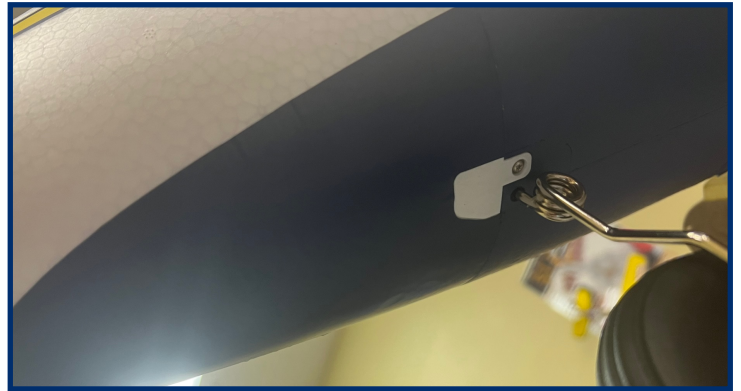

BATTERY INSTALLATION

1. Push the spring-loaded battery latch tab back to release the battery hatch. Lift the hatch away from the fuselage, starting at the front.
2. Remove the battery tray by loosening the thumb screw. Slide the tray rearward as you gently lift the tray away from the fuselage.
3. Install an adhesive-backed hook strip to the battery tray, and an adhesive-backed loop strip to the battery.
4. Place the battery on the tray, and secure it in place with the hook and loop straps provided.
5. Re-install the tray into the battery compartment by aligning the front tab on the tray with the appropriate slot in the fuselage sub-frame. Once seated in place, secure the tray to the sub-frame using the thumb screw.
6. Reinstall the hatch, and confirm that the latch has positively engaged.

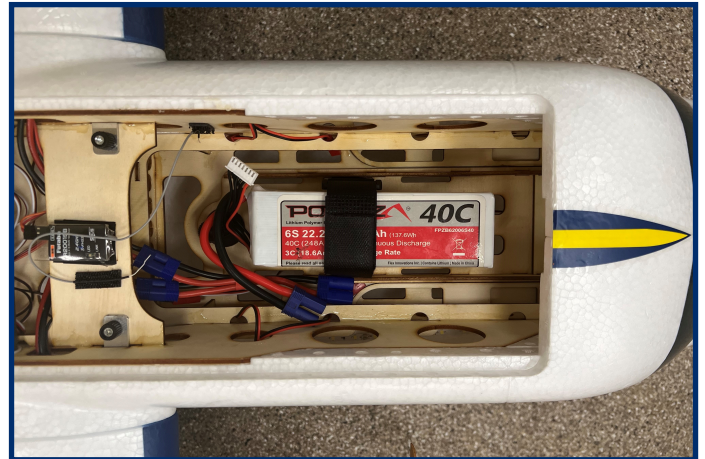

⚠ CAUTION

Always keep limbs clear from the propellers when the battery is connected. After the ESC arm, the propellers will rotate when the throttle is moved. Unlike an internal combustion engine, electric motors apply more voltage to counteract resistance, therefore any object that is entangled in the propellers will be severely damaged before the motors will stop

⚠ WARNING

When making adjustments to linkages, transmitter settings, or the Aura 8 flight control system, remove the propellers to guard against accidental spool up.

CENTER OF GRAVITY VERIFICATION

The Twin Otter 80E does not fly like your typical acrobatic or 3D model, for that reason it is important that you do not stray from the recommended CG. Flex has done extensive flight testing to arrive with this range. In particular, **DO NOT** fly the airplane more tail heavy than recommended, it will not perform as expected.

The CG is located between 3-5/16 and 3-3/4 inches (85mm and 95mm) from the leading edge of the wing.

These CGs were measured by lifting the completed airplane upright, with all components installed. This location was determined from many test flights by designer and multi-time world aerobatic champion, Quique Somenzini. Lift the airplane from the underside of the wing to check CG.

Note that the wing tube is at exactly 95mm so this can be used to find the rearmost CG quickly if desired. This can be done by removing the hatch and lifting the airplane from the wing tube to check for CG.

Setting the center of gravity is one of the most important steps for success, particularly with a new airplane. The Twin Otter 80E is a high-performance airplane with large control surface throws, and a high thrust-to-weight ratio. These two factors combined make it a very enjoyable aircraft to fly, but if the CG is not within an acceptable range, it will make the aircraft difficult, if not impossible, to control.

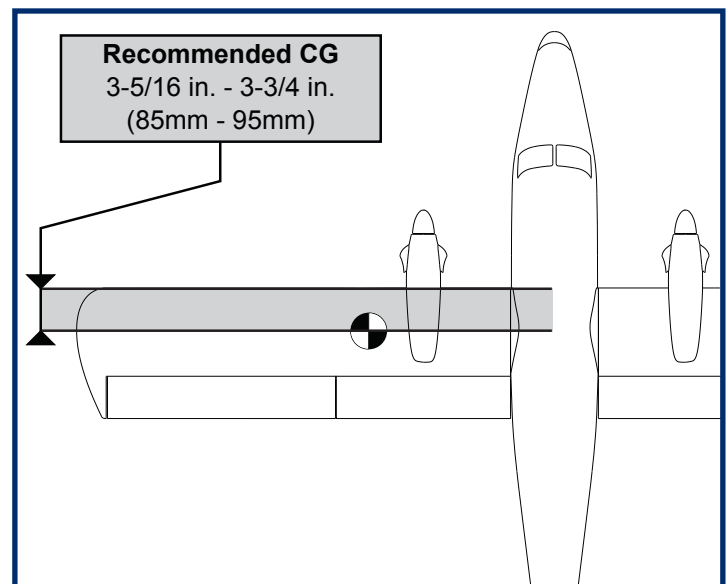

⚠ NOTICE

The CG measurement should be made with the completed airframe with all components (batteries, servos, receiver, linkages, screws, bolts, hardware, etc.) installed. Failure to do so will result in inaccurate measurement.

PRE-FLIGHT CHECKLIST



DIFFERENTIAL THRUST WARNING!



The Twin Otter 80E implements differential thrust when in Flight Mode 3, this means that one of the motors can spool up whenever rudder input is provided or the airplane is rotated. For this reason please follow these recommendations:

- Never activate Flight Mode 3 until you are ready to take-off, the airplane may accelerate unexpectedly. Taxi to and from the runway in Flight Mode 2.
- If the battery is plugged in, always handle and carry the airplane from the rear and with all body parts clear of the propellers.
- **We recommend that you assign the differential thrust disable switch to your throttle hold and only engage throttle when you have cleared the airplane and are ready to taxi and take off.**

To help ensure a successful first flight, as well as many flights after, perform a few simple pre-flight checks to be sure the aircraft is ready to fly:

1. Verify the ailerons, flaps, elevators and rudder are properly hinged and in good working order. Pinch a control surface between your thumb and forefinger and grasp the stabilizers with your other hand. Attempt to move the control surface back and forth perpendicular to the stabilizer (see Figure 1). Watch the hinges for movement. If you find any loose hinges, apply Foam-Cure or 15/30 minute Epoxy, being sure to stay away from the hinge pivot, to the loose side(s) of the hinge(s) and re-insert into its location. **DO NOT apply thin CA to pin hinges!** Ensure that the hinge moves freely.
2. Verify all control surfaces move freely when disconnected from the servo. If you have a tight or binding surfaces that use pin hinges, apply a small drop of light oil to each hinge pivot. Move the surface back and forth to work the oil into the hinge. Repeat as needed.
3. Verify that all hardware and other aircraft parts are properly secured, including those connections that require blue thread lock. This includes hardware and parts installed by the factory.
4. Verify your battery is fully charged and in good condition. Avoid using batteries with swollen cells, or batteries that do not charge back to their full capacity.
5. Verify that the CG is in the proper location and that the battery is secured in place.
6. Ensure the Aura is on and functioning properly. Power on your transmitter, followed by the aircraft. Ensure the Aura is calibrated properly and receiving a valid radio source (solid orange+solid green LEDs).
7. Verify transmitter stick inputs result in the proper control surface movements (reference page 20) and the Aura flight modes work properly.
8. Verify aircraft movement results in proper Aura sensor corrections (reference page 21).
9. Verify the motor and ESC function properly. Point the aircraft in a safe direction. Hold the airframe firmly, smoothly advance the throttle to full and back to idle. Listen and watch for any odd or unusual behavior for the motor or speed controller.

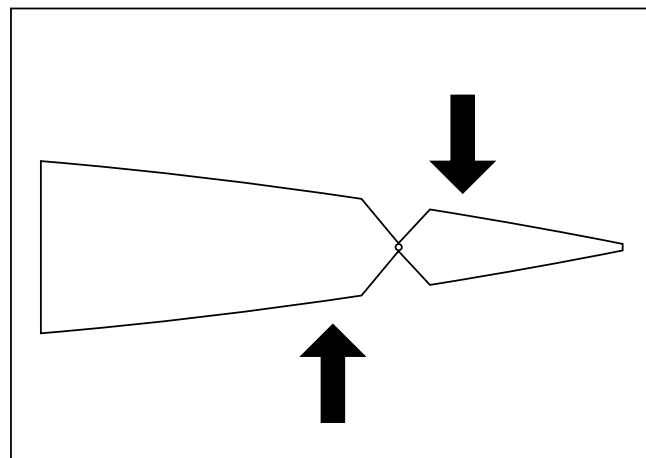

Figure 1 - Test for hinge movement and loose hinges

AMA SAFETY CODE

When flying your aircraft, we recommend following the guidelines set by the Academy of Model Aeronautics (AMA). You can find their safety handbooks as well as more information on the AMA at their website, located at the address below:

www.modelaircraft.org

TWIN OTTER 80E AURA OPTIONAL FEATURES CONFIGURATION

The Aura installed in your Twin Otter 80E comes with the Quick Set feature. Quick Set allows the pilot to adjust options in the Aura without the use of a computer. The options of the Twin Otter 80E are described below:

- Crow Mode switch: A switch can be used to activate Crow Mode (sometimes called Butterfly) during any Flight Mode. Crow Mode simultaneously deflects the ailerons up and the flaps down to act as air brakes. The crow configuration is inversely proportional to throttle so that full crow deflection at 0% throttle reducing to zero crow deflection at 50% throttle .

To use this feature, you will need a minimum 8 channel transmitter. If you wish to have a switchable Night LED setup, with crow, you will need a minimum 9 channel transmitter with the 9th channel enabled on your receiver .

Twin Otter 80E Optional Feature Transmitter Setup

CH 8 (Aux 3) | Crow Switch (Optional) → Assign to 2-position switch

Flight Modes are as described in the table on page 14

Quick Set Procedure

Step 1 - Enter Quick Set Mode

1. Make sure all power is off on the Twin Otter 80E
2. Remove the prop before making changes
3. Turn on your transmitter
4. Remove the Servo lead from Aura Port S2.
5. Install a bind plug in Aura Port S2.
6. Plug in the motor battery to power up the Twin Otter 80E
7. After entering the Quick Set mode, the Orange LED will be off and the Green LED will be on SOLID. Initially the Blue and Red LEDs will also be off.

Step 2 - Choose Profile

After entering Quick Set mode as described above, you toggle the Crow Mode switch (CH8) on the transmitter to enable or disable the different options.

8. If you want to activate the Crow Mode switch, toggle the CH8 switch on your transmitter .
 - If the RED LED is ON, the Crow Mode switch is ENABLED .
 - If the RED LED is OFF, the Crow Mode switch is DISABLED .

Step 3 - Saving your Selections

9. After setting the Crow Mode option as desired, remove the bind plug to save your settings. The Blue, Green, and Red LEDs will briefly turn on while the Aura is saving, then return to their previous state .
10. Completely power off the Twin Otter 80E and Aura
11. Replace the Servo Lead in Aura Port S2
12. Power up and Fly as usual with your new Aura Profile!

Note: This process can be repeated as many times as desired to enable or disable Crow Mode.

FLYING YOUR TWIN OTTER 80E



DIFFERENTIAL THRUST WARNING!



The Twin Otter 80E implements differential thrust when in Flight Mode 3, this means that one of the motors can spool up whenever rudder input is provided or the airplane is rotated. For this reason please follow these recommendations:

- Never activate Flight Mode 3 until you are ready to take-off, the airplane may accelerate unexpectedly. Taxi to and from the runway in Flight Mode 2.
- If the battery is plugged in, always handle and carry the airplane from the rear and with all body parts clear of the propellers.
- **We recommend that you assign the differential thrust disable switch to your throttle hold and only engage throttle when you have cleared the airplane and are ready to taxi and take off.**

Selecting a Flying Site

Selecting a flying site is critical to a successful flight. Airplanes require a lot more room than other R/C products, therefore, a neighborhood or parking lot is less than ideal. A large open field with short grass and generous overfly area are the best candidates if no AMA field is available in your area. Know your overfly area - ensure that there are no houses, playgrounds, or other buildings that may be damaged if the airplane were to crash.



Takeoff

Taxi or place the aircraft on the runway centerline, with the nose pointed into the wind. Select Flight Mode 2, then set throttle trim so that the motor spins at its lowest RPM without stopping. For the first flight, leave the flaps in the up position. Smoothly advance the throttle to full while maintaining directional control with the rudder and slight back pressure on the elevator. The airplane should lift off smoothly before the throttle is fully open. Fly in Flight Mode 2 until the aircraft is fully trimmed (see special trimming instructions), and you are comfortable with its handling, then explore the other modes as desired.

Flying

Altitude is your friend on the first flight. Briskly climb to a safe altitude and trim the airplane out. The airplane should fly straight and level at 2/3 to 3/4 power with no hands on the transmitter. Try some basic maneuvers, and slowly progress into the airplane's flight envelope as you become more comfortable with the airplane's flight qualities and perfect your setup. Note: If at any time you experience unexpected control system inputs or oscillations, switch to Flight Mode 1 and reduce speed immediately, land and troubleshoot the issue.

Landing

Be mindful of your flight time and allow adequate battery reserve for a couple of go-arounds, if necessary, on the first few flights. Select Flight Mode 2 and slow the airplane and align with the runway, into the wind. For your first landing, leave the flaps in the up position. The airplane should descend smoothly in this configuration with proper airspeed. Once you are close to the ground, gradually close the throttle fully and begin to smoothly apply up elevator as required to arrest descent and the airplane should gently touch down with a short roll out.

Trimming

Transmitter trim or sub-trim will cause trim shifts when different flight modes are selected. To eliminate this trim shift, the model should be mechanically trimmed, or Aura **Quick Trim** may be used instead.

Aura Quick Trim

The Aura 8 features a Quick Trim Mode that eliminates the need for mechanical linkage adjustments during test flights. Aura will learn the trim values from your transmitter, and apply them to the control surfaces at power up when enabling quick trim mode.

NOTE: Quick Trim can also be used BEFORE flying to make small changes to center the control surfaces before flight.

1. Fly the airplane in Flight Mode 2 at 2/3 power. Trim the aircraft with the transmitter trimmers and land. **DO NOT CHANGE FLIGHT MODES.**
2. Power off the Twin Otter 80E. Insert a bind plug into Aura Port S3 (you will need to remove the servo lead that is currently in S3). Check the transmitter is on and re-power the Aura to enter Quick Trim.
3. Wait 5 seconds for the Aura to completely initialize. Confirm Quick Trim mode is active by checking the Blue LED is slowly flashing.
4. Remove the bind plug from Aura Port S3 to save your trim settings. The Blue LED will flash quickly after control surface trim values are stored. While the trim values are stored in Aura, they are not applied to the control surface(s) until the Aura is re-powered.
5. Remove power from the Twin Otter 80E and center all control surface trims on the transmitter.
6. Re-install the servo that was previously removed into port S3.
7. Re-power the Twin Otter 80E. The control surfaces should be unchanged even though the trim has been centered on the transmitter.
8. Switch between other Flight Modes to ensure you do not see any changes in trim.

NOTE: Quick Trim may be repeated as needed for fine tuning, or if changes to the aircraft are made.

NOTE: Ensure Aileron/Elevator/Rudder sub-trims are at zero in the transmitter **BEFORE** flying for the Quick Trim process to work properly.

AIRFRAME REPAIRS

The Twin Otter 80E is molded from durable EPO foam and is repairable with most adhesives. Similar to building and repairing wood or composite airplanes, the correct glue for a given application is critical to the repair holding and not breaking again. For major repairs, such as a broken fuselage, epoxy is preferred because it allows time to correct any misalignment. For smaller repairs, such as a cracked control surface or small chunk of material missing from the airframe, regular CA is very effective. The use of odorless (foam safe) CA is not required and not recommended on EPO foam aircraft because it takes a longer period of time to cure than regular CA and the bond tends to be weaker.

NOTE: Avoid the use of CA accelerant in repairs. It can damage paint and will weaken the bond of the glue. If CA accelerant is used, be mindful of the locations of CA to prevent premature bonding of parts, or bonding a hand or clamp to the airframe.

If a part is damaged too badly to be repaired, please refer to the table on page 3 for a complete listing of spare airframe parts.

WARNING

Note: Do not use thread locker on any metal to plastic connection including the bolts holding the push rods to the servos or the control horns (they use lock nuts and will not back out)!

Using thread locker will weaken the plastic, void your warranty, and cause your airplane to crash!

NOTICE

If a crash is imminent, fully reduce the throttle to prevent further damage to the power system and reduce energy to lessen impact damage. Never allow the propeller to contact the ground under power, even idle.

CRASH DAMAGE IS NOT COVERED UNDER ANY PRODUCT WARRANTY.

NOTE: Avoid keeping the airplane in direct sunlight when not flying. Excessive heat can damage the airplane's structure and UV damage can permanently discolor decals.

REPLACING SERVOS

Required Tools and Fasteners: #1 Phillips Screwdriver

1. Disconnect the servo from the Aura 8.
2. Unscrew the servo arm from the servo and remove the servo arm.
3. Unscrew the two servo mounting screws at each end of the servo and remove. Note that some servos may be connected to a servo extension. This extension should be left in the wing or fuselage when the servo is replaced.

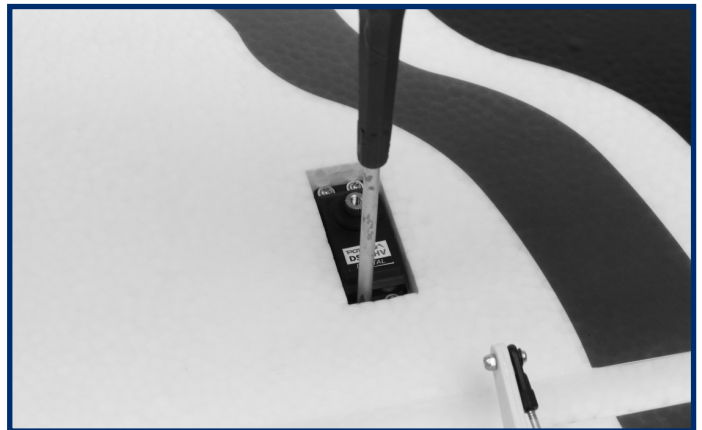

AIRCRAFT TROUBLESHOOTING GUIDE

Should you encounter any abnormal situations with your Twin Otter 80E, refer to the table below to determine the probable cause and a recommended solution for the issue. If the required solution does not rectify the problem, please contact product support at support@flexinnovations.com for further

! NOTICE

Unless specifically required, ALWAYS troubleshoot the airplane with the propeller removed.

DISCREPANCY	PROBABLE CAUSE	RECOMMENDED SOLUTION
Motor non-responsive (no ESC initialization tones audible)	Throttle not at idle and/or throttle trim too high	Lower throttle stick and trim completely. If problem persists, ensure that the sub-trim and travel adjust are properly set in the radio's programming
	Motor disconnected from ESC	Ensure plugs are fully seated. Check battery and/or plugs for damage and replace any damaged components found - DO NOT ATTEMPT REPAIR
Motor non-responsive (throttle calibration tones received)	Throttle channel is reversed	Reverse throttle channel in radio programming
Motor turns in the wrong direction	The three motor wires are connected incorrectly to the ESC	Swap any TWO motor wires
Reduced flight time or aircraft underpowered	Battery not fully charged	Ensure battery is fully charged prior to installing in aircraft
	Propeller installed backwards	Install propeller so that the convex side faces forward (tractor configuration)
	Battery is too weak or damaged	Remove battery from service completely and replace with a different battery
	Ambient temperature is too cold	Ensure battery packs are adequately warm (70°F/21°C) before flight
	Battery capacity too small for intended use	Replace battery with one of proper capacity and discharge capacity
	ESC reaching preset LVC (low-voltage cutoff)	Recharge flight battery or reduce flight time
	Battery's discharge rating may be too small	Replace battery with one with higher 'C' rating
Excessive propeller noise and/or vibration	Damaged spinner and/or propeller, collet, or motor	Replace damaged components - DO NOT ATTEMPT REPAIR
	Propeller is not balanced	Balance or replace the propeller
	Prop nut is loose	Tighten prop nut with appropriate-sized wrench
	Spinner is not fully in place or tightened	Loosen the spinner bolt, adjust as required, retighten spinner bolt
	Propeller nut or propeller adapter threads not cut straight	Replace propeller nut or propeller shaft - DO NOT ATTEMPT REPAIR
Control surfaces nonresponsive	Airframe or control linkage system damage	Examine airframe for damage, repair as required; inspect control linkage system (servo, pushrod, control horn) for damaged components and replace as required
	Wire damaged or connector loose	Examine wires and connections, replace as necessary
	Transmitter bound incorrectly, incorrect active model memory, incorrect Aura data input configuration, incorrect Aura transmitter settings	Consult radio manual for proper binding and model selection instructions
	Battery voltage too low	Use volt meter to check battery; recharge or replace as necessary
	Battery disconnected from ESC	Check that the ESC plugs are fully seated
	BEC (battery elimination circuit) damaged	Replace ESC - DO NOT ATTEMPT REPAIR
	Damaged Servo	Replace Servo - DO NOT ATTEMPT REPAIR
Failed control direction test	Incorrect Aura 8 or Transmitter Setting - DO NOT FLY!	Reference transmitter and receiver sections of this manual. Refer to control surface direction chart and transmitter setup; adjust appropriate settings as required. Check Twin Otter 80E and Aura wiki web pages for additional information. If no solution is found, contact customer support at support@flexinnovations.com
Failed Sensor Direction Test	Aura 8 is not mounted in the proper orientation	Mount Aura in the proper orientation
	Aura 8 settings incorrect	Reference the transmitter and receiver sections of this manual. If no solution is found, contact customer support at support@flexinnovations.com
Control surface oscillation	Exceeding maximum airspeed for configuration	Reduce airspeed
	Gains too high for aircraft/flight configuration	Refer to Aura 8 manual to decrease desired control surface gain
	Propeller/spinner not balanced	Balance or replace propeller and/or spinner
	Motor vibration	Inspect motor mounting bolts and re-tighten as necessary
	Loose Aura 8 mounting	Re-align and secure the Aura 8 to the aircraft
	Control linkage slop	Examine control system and repair or replace worn components
	Improper transmitter setup	Refer to Aura 8 manual to correctly configure transmitter
	Damaged propeller or spinner	Replace damaged component- DO NOT ATTEMPT REPAIR
	Improperly set master gain	Ensure master gain is set for proper gain value
Trim changes between flight modes	Trims are not properly zeroed	Readjust control linkage and re-center trims in radio
	Sub-trim is not properly zeroed	Remove sub-trim; adjust the servo arm or clevis to achieve proper geometry
	Transmitter is not properly calibrated (aileron/elevator/rudder are not neutral with sticks centered; reference transmitter monitor)	Calibrate transmitter (reference manufacturer's instructions, or return to manufacturer for calibration)
Gyro doesn't respond to aircraft movements	Incorrect Flight Mode selected	Gyro is only enabled in Flight Modes 2 and 3, check that you are not testing the gyro in Flight Mode 3

LIMITED WARRANTY

Warranty Coverage

Flex Innovations LLC and its authorized resellers ("Flex") warrant to the original purchaser that this product (the "Product") will be free from defects in materials and workmanship at the date of purchase.

Outside of Coverage

The warranty is not transferable and does not cover:

- (a) Products with more than 45 days after the purchase date
- (b) Damage due to acts of God, accident, misuse, abuse, negligence, commercial use, or due to improper use, installation, operation, or maintenance
- (c) Damage to other components or assemblies associated with the use of the Product.
- (d) Modification of or to any part of the Product
- (e) Product not purchased from an authorized Flex Innovations dealer or distributor.
- (f) Product that has been partially, or fully assembled
- (g) Shipping damage
- (h) Cosmetic damage
- (i) Services or labor associated with the repair, use or assembly of the Product.

OTHER THAN THE EXPRESS WARRANTY ABOVE, FLEX MAKES NO OTHER WARRANTY REPRESENTATION, AND HEREBY DISCLAIMS ALL IMPLIED WARRANTIES, INCLUDING, WITHOUT LIMITATION, THE IMPLIED WARRANTIES OF NONINFRINGEMENT, MERCHANTABILITY AND FITNESS FOR A PARTICULAR PURPOSE. THE PURCHASER ACKNOWLEDGES THAT THEY ALONE HAVE DETERMINED THAT THE PRODUCT WILL SUITABLY MEET THE REQUIREMENTS OF THE PURCHASER'S INTENDED USE.

Purchaser's Remedy

Flex's sole obligation and purchaser's sole and exclusive remedy shall be that Flex will, at its option, either (i) service, (ii) replace any part of the Product determined by Flex to be defective, or (iii) replace the Product determined by Flex to be defective. Flex reserves the right to inspect all Product(s) involved in a warranty claim. Service or replacement decisions are at the sole discretion of Flex. Proof of purchase is required for all warranty claims. **SERVICE OR REPLACEMENT AS PROVIDED UNDER THIS WARRANTY IS THE PURCHASER'S SOLE AND EXCLUSIVE REMEDY.**

Limitation of Liability

FLEX SHALL NOT BE LIABLE FOR SPECIAL, INDIRECT, INCIDENTAL OR CONSEQUENTIAL DAMAGES, LOSS OF WAY, REGARDLESS OF WHETHER SUCH CLAIM IS BASED IN CONTRACT, WARRANTY, TORT, NEGLIGENCE, STRICT LIABILITY OR ANY OTHER THEORY OF LIABILITY, EVEN IF FLEX HAS BEEN ADVISED OF THE POSSIBILITY OF SUCH DAMAGES.

Further, in no event shall the liability of Flex exceed the individual price of the Product on which liability is asserted. As Flex has no control over use, setup, assembly, modification or misuse, no liability shall be assumed nor accepted for any resulting damage and/or injury. By the act of use, setup or assembly, the user accepts all resulting liability. If you as the purchaser or user are not prepared to accept the liability associated with the use of the Product, purchaser is advised to return the Product immediately in new and unused condition to the place of purchase.

Law

These terms are governed by Florida law (without regard to conflict of law of principals). This warranty gives you specific legal rights, and you may also have other rights which vary from state to state. FLEX RESERVES THE RIGHT TO MODIFY THIS WARRANTY AT ANY TIME WITHOUT NOTICE.

Questions & Assistance

Contact Us By:

E-Mail – support@flexinnovations.com

Phone – 1 (866) 310-3539

Inspection or Services

If this Product needs to be inspected or serviced and is compliant in the region you live and use the Product in, please contact your regional Flex authorized reseller. Pack the Product securely using the original shipping carton. Please note that both the inner and outer boxes need to be included. The inner box is not designed to withstand the rigors of shipping without additional protection from the outer shipping carton. Ship via a carrier that provides tracking and insurance for lost or damaged parcels, as Flex is not responsible for merchandise until it arrives and is accepted at our facility.

Warranty Requirements

For Warranty consideration, you must include your original sales receipt verifying the proof of purchase date. Provided any warranty conditions have been met, your Product or its defective parts will be replaced or serviced free of charge. Responsibility of shipping charges are as follows:

To Flex from customer, Customer is responsible.

To Customer from Flex, Flex is responsible.

Service or replacement decisions are at the sole discretion of Flex.

COMPLIANCE INFORMATION FOR THE EUROPEAN UNION

	Declaration of Conformity (In accordance with ISO/IEC 17050-1)	
	Product(s):	Twin Otter 80E Super PNP
	Item Number(s):	FPM5070A FPM5080A

The object of declaration described above is in conformity with the requirements of the specifications listed below, following the provisions of the EMC Directive 2004/108/EC.

EN 55022: 2010+AC: 2011

EN 55024: 2010

EN 61000-3-2: 2006+A2:2009

EN 61000-3-3: 2013

EN 61000-6-3: 2007/A1:2011

EN 61000-6-1: 2007



Instructions for disposal of WEEE by users in the European Union

This product must not be disposed of with other waste. Instead, it is the user's responsibility to dispose of their waste equipment by handing it over to a designated collections point for the recycling of waste and electronic equipment. The separate collection and recycling of your waste equipment at the time of disposal will help to conserve natural resources and ensure that it is recycled in a manner that protects human health and the environment. For more information about where to drop off your waste equipment for recycling, please contact your local city office, your household waste disposal service or where you purchased the product.

Building and Flying Notes

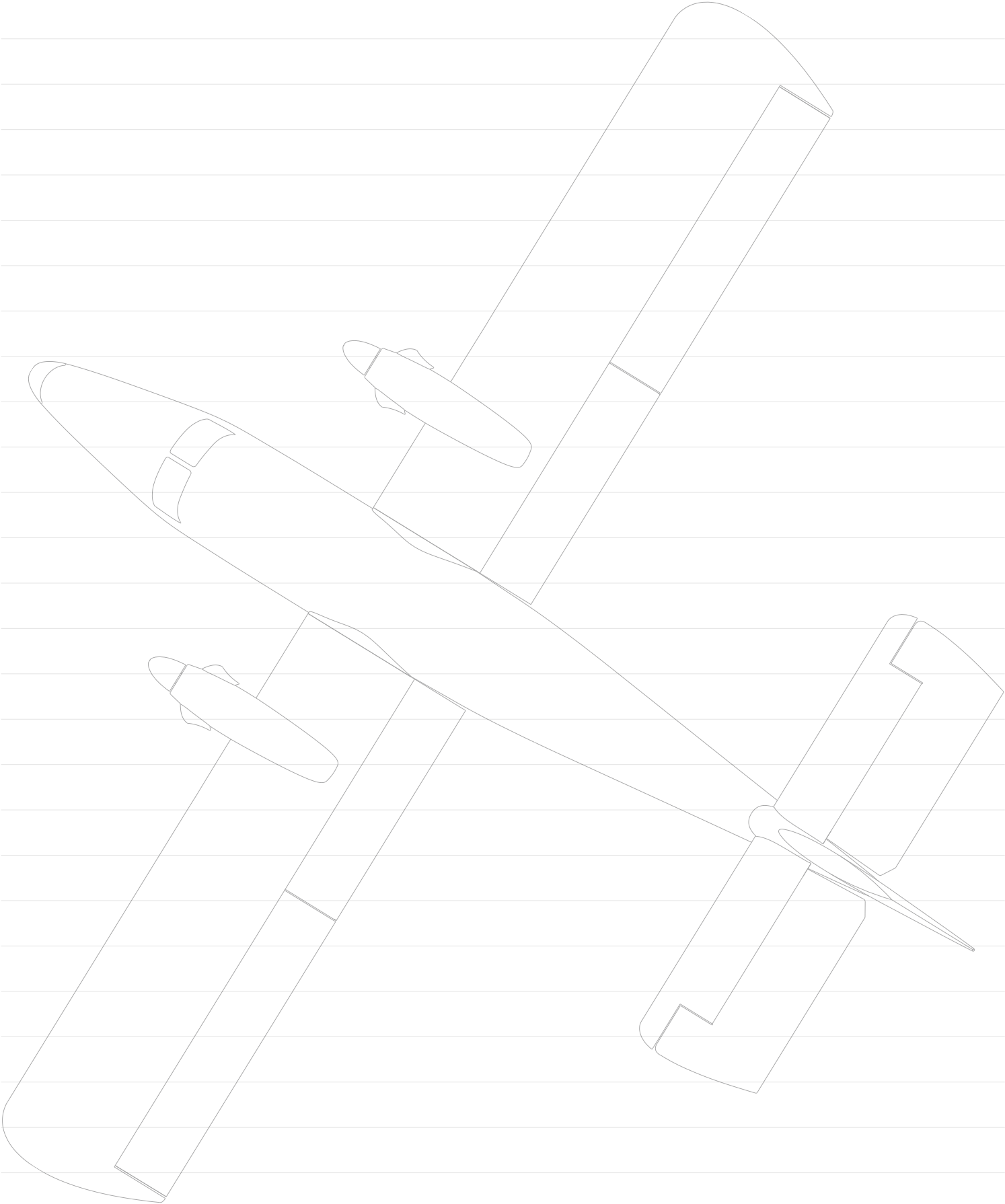

Enjoy your Flex Innovations Twin Otter 80E!



© 2023 Flex Innovations, LLC. All rights reserved.
Potenza™ is a trademarks of Flex Innovations LLC
DSM®, DSM2™, and DSMX™ are trademarks of Horizon Hobby, Inc.
Futaba is a registered trademark of Futaba Denshi Kogyo Kabushiki Kaisha Corporation of Japan.
Jeti, UDI, and Jeti Model are trademarks or registered trademarks of Jelen, Ing. Stanislav of Czech Republic
HoTT is a registered trademark of SJ, Inc.