

Instruction Manual

ARF

EDGE 540

120CC
G2 EDITION

BY JASE "THE ACE" DUSSIA

JASE
"THE ACE"



FOX
INNOVATIONS™



BEFORE CONTINUING WITH THIS INSTRUCTION MANUAL OR THE ASSEMBLY OF YOUR AIRCRAFT, PLEASE VISIT OUR WEBSITE FOR THE LATEST PRODUCT UPDATES, FEATURE CHANGES AND MANUAL ADDENDUMS FOR THIS PRODUCT.

www.flexinnovations.com/product/edge-540-120cc-g2-arf

TABLE OF CONTENTS

| | |
|--|-----------|
| Introduction | 1 |
| Specifications: | 2 |
| Required Equipment: | 2 |
| Optional Equipment: | 3 |
| Ultracote®/Oracover® Colors:..... | 4 |
| Using this Manual | 5 |
| Airframe Assembly | 7 |
| Rudder Control Horn Installation | 7 |
| Main Landing Gear Installation | 9 |
| Landing Gear Installation..... | 9 |
| Landing Gear Cuff Installation | 10 |
| Wheel, Axle, and Wheel Pant Installation | 11 |
| Rudder and Tailwheel Installation | 14 |
| Rudder Installation..... | 14 |
| Rudder Servo Opening | 15 |
| Tailwheel Installation | 15 |
| Aileron Servo and Linkage Installation | 17 |
| Elevator Servo and Linkage Installation | 21 |
| Rudder Servo and Linkage Installation | 24 |
| Gas Power Setup | 26 |
| Fuel Tank Installation | 26 |
| Engine Installation | 29 |
| Mount the Engine..... | 29 |
| DA-120 Throttle Servo and Linkage Installation | 30 |
| Ignition Installation | 32 |
| Exhaust and Cowling Installation | 35 |
| Muffler Installation (A) | 35 |
| Canister Installation (B)..... | 37 |
| Engine Baffling and Cooling Installation..... | 38 |
| Cowling, Propeller and Spinner Final Installation | 40 |
| Radio Installation | 41 |
| Side Force Generators Assembly | 44 |
| Field Assembly | 45 |
| Decal Installation | 50 |
| Final Setup and Flying Notes | 55 |
| Center of Gravity..... | 55 |
| Aura 8 Professional..... | 56 |
| Range Testing..... | 57 |

| | |
|---------------------------------------|-----------|
| Before First Flight | 57 |
| AMA Safety Code | 58 |
| Replacement Parts..... | 59 |
| Optional Accessories..... | 60 |
| Limited Warranty | 61 |
| Building and Flying Notes..... | 63 |

INTRODUCTION

Flown to **1st place by Jase “The Ace” Dussia** at the Del Norte Fly Fest 2023, the Flex Innovations Edge 540 120cc proves to be a testament to excellence in aerobatic competition. The Edge 540 120cc not only captures the sleek aesthetics of its full-size counterpart but also boasts exceptional performance capabilities. Its design is a nod to the full scale Zivko Edge 540, ensuring an authentic and captivating appearance in the skies. Beyond its striking visual appeal, the Edge 540 120cc is a true performer, excelling across a broad range of flying styles. Whether you’re into low and slow 3D maneuvers, high-energy XA flights, or precision flying, the Edge 540 delivers an impressive flight envelope to meet your every expectation.

In 2023, Flex set out on a goal to bring the Edge to forefront of aerodynamic performance along with expanding the inclusivity of features for assembly. Now, the Edge 540 120cc G2 raises the bar in its class by combining an easy to fly yet capable flight envelope with innovative features and next level ease of assembly. The Edge features the Flex Innovations Speed-Lock system, pre-installed and painted control horns, clear cowling template for exhaust cutting, easily removable landing gear due to blind nuts, and much more! Constructed with a modern blend of laminated plywood and carbon fiber, the Edge 540 120cc G2 achieves a perfect balance of lightweight agility and structural strength. Two distinctive Clint Sweet Designs color schemes ensure that this aerobatic marvel stands out in any crowd. Add the Edge 540 120cc G2 to your hangar and experience a level of performance and design that sets it apart as a must-have for aviation enthusiasts!

Specifications:

| | |
|--|---------------------|
| Wingspan: | 102 in. (2590mm) |
| Length: | 102.2 in. (2595mm) |
| Estimated Weight: (DA-120 w/standard muffler) | 27.75 lb. (12.59kg) |
| Engine Size: | 100-125cc |

Required Equipment:

Radio Equipment & Servos:

| | |
|---------------------|---|
| Transmitter: | 8+ channels |
| Receiver: | 8+ channels, high-voltage capable |
| Receiver Battery: | (2) 2S 2000mAh 15C+ LiPos (FPZBR20002S15 recommended) |
| Recommended Servos: | (7) Minimum 450 oz/in (32.4 kg/cm) for control surfaces & (1) standard servo for throttle. (8) Potenza DS49010BLHV Servos (FPZDS49010BLHV recommended) |

Servo Arms:

| | |
|-----------------------------|--|
| Aileron, Elevator & Rudder: | (7) Potenza 2-inch Clamping Servo Arm (Push-Pull Rudder) (FPZA1036B recommended) |
|-----------------------------|--|

Servo Extensions:

| | |
|------------|---|
| Ailerons: | Root Servo (Inside Wing) – None Required Tip Servo (Inside Wing) – (2) 12-inch (305mm) FPZA1045 All Aileron Servos (Inside Fuselage) – (4) 12-inch (305mm) FPZA1045 Optional MPX Double Servo connector – (2) FPZA1066 |
| Elevators: | (2) 48-inch (1200 mm) FPZ1049 |
| Rudder: | Tail-Mounted Push-Pull – (1) 36-inch (920 mm) FPZA1048 Forward-Mounted Pull-Pull – None Required |
| Throttle: | (1) 9-inch (230cm) FPZA1044 |

Spinner:

| | |
|----------|---|
| Spinner: | 5-inch (127 mm) Flex Innovations 5-Inch Carbon Fiber, Ultimate Style Spinner (FPM2426A & FPM2426B recommended) |
|----------|---|

Gas Engine Setup

| | |
|------------------------|--|
| Engine: | 100-125cc Two-Stroke Engine Desert Aircraft DA-120 or GP-123 recommended |
| Exhaust: | Follow your engine manufacturer's recommendation, as well as local noise restrictions in your area. Desert Aircraft Stock Muffler Set (FPMDA120MUFFLER) recommended |
| Other Exhaust Options: | KS 3086 Canisters (Rear Exit) 90mm drop flexible header for the DA-120 |
| Propeller: | Follow your engine manufacturer's recommendation. Falcon 28 x 9.5 recommended for the DA-120 on stock mufflers |
| Engine Standoffs: | (4) 20 mm Aluminum Engine Standoffs (FPM1624 recommended) |
| Ignition Regulator: | Follow your engine manufacturer's recommendation |
| Ignition Battery | Follow the manufacturer's voltage requirements. Potenza 2S 2000mAh 15C+ Li-Po (FPZBR20002S15) recommended |
| Fuel Dot: | McFueled Fuel Dot (FPMA1049) |

Optional Equipment:

| | |
|--------------|---|
| FPZAURA08PRO | Aura 8 Professional |
| FPM1623 | 32oz Lightweight Fuel/Smoke Tank (for smoke) |
| DP1000 | Dualsky DP1000 Brushless Smoke Pump |
| FPM1314 | Flex Innovations Premium Wing and Tail Bag Set |
| FPM2416A | Edge 540 120cc G2 Pilot Figure Yellow |
| FPM2416B | Edge 540 120cc G2 Pilot Figure Green |
| FPM1332 | Protection Pack – Edge 120cc |
| FPM2426A | 5" Carbon Fiber Spinner Yellow/Red/Grey Edge G2 Scheme |
| FPM2426B | 5" Carbon Fiber Spinner Green/Silver/White/Black Edge G2 Scheme |

Ultracote®/Oracover® Colors:

GREEN Scheme:

Ultracote®

Royal Green (only available through Flex FPM1316)

Silver (HANU881)

Black (HANU874)

White (HANU870)

Oracover®

Silver (21-023)

Black (21-071)

White (21-010)

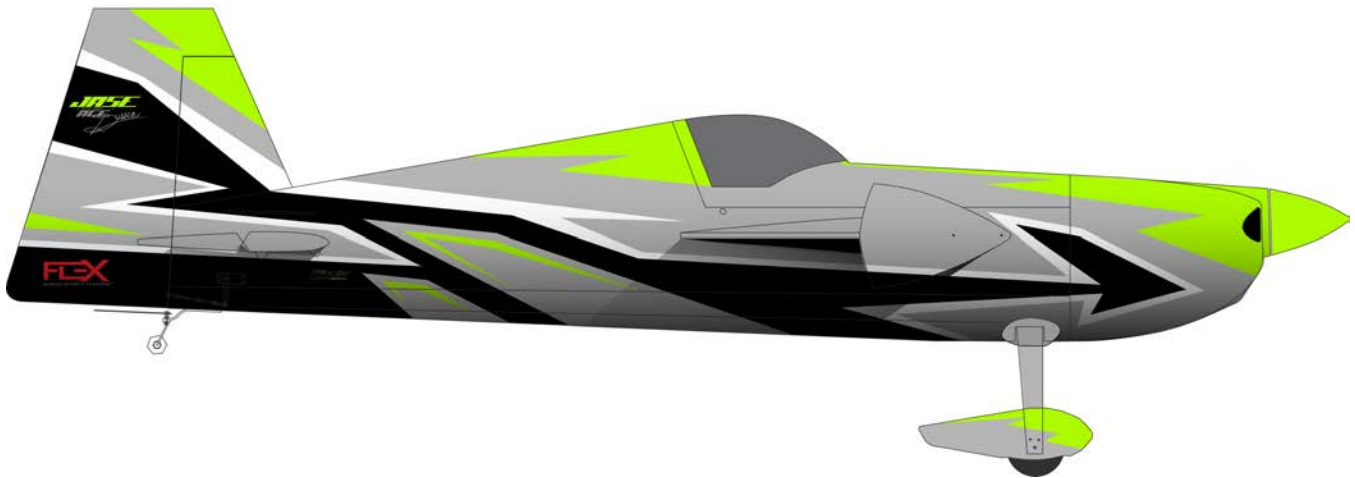

Yellow Scheme:

Ultracote®

Cub Yellow (HAN884)

True Red (HANU866)

Light Gray (HANU882)

Black (HANU874)

Oracover®

Cub Yellow (21-030)

Ferrari Red (21-023)

Grey (21-011)

Black (21-071)

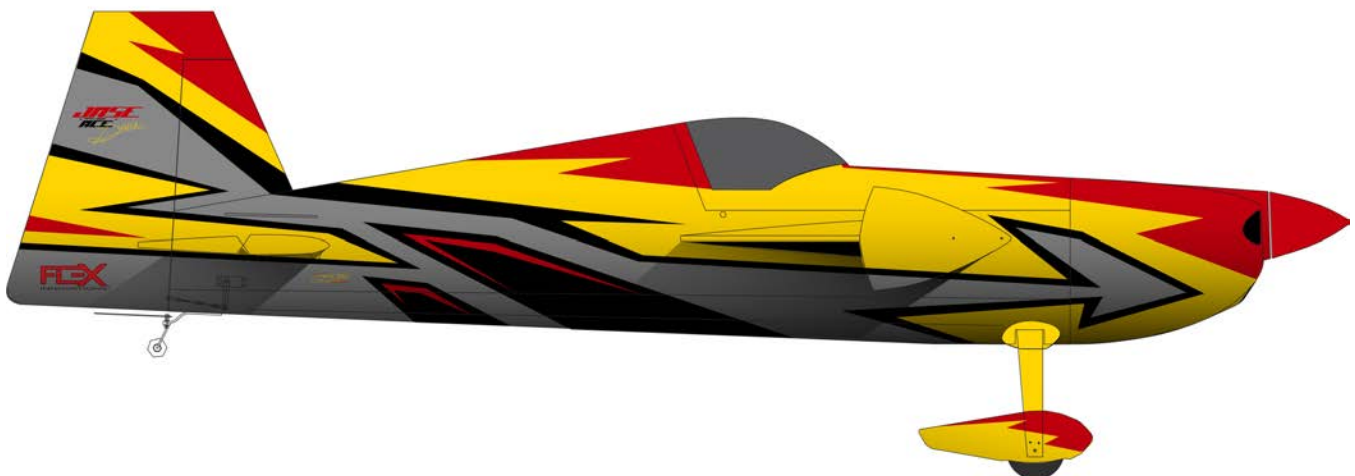

USING THIS MANUAL

The manual is divided into sections to make the assembly of the airplane easier to follow.

Note: The squares “□” next to each step that can be checked off to help you keep track of the steps that have been completed.

ATTENTION

Read the ENTIRE instruction manual to become familiar with the features and assembly of the product before starting assembly. Failure to assemble or operate the product correctly can result in damage to the product, personal property and cause serious or fatal injury.

All instructions, warranties and other collateral documents are subject to change at the sole discretion of Flex Innovations, LLC. For up-to-date product literature, please visit our website at www.flexinnovations.com and navigate to the product page for this product.

WARNING

This is NOT a toy. This product is not intended for use by children under 14 years of age without direct adult supervision.

IMPORTANT INFORMATION REGARDING WARRANTY

Please read our Warranty and Liability section before building this product. If you as the purchaser or user are not prepared to accept the liability associated with the use of this product, you are advised to return this product immediately in new and unused condition, in the original packaging material, to the place of purchase.

SAFETY WARNINGS AND PRECAUTIONS

Protect yourself and others by following these basic safety guidelines.

1. This manual contains instructions for safety, operation, and maintenance. It is essential to read and follow all the instructions in the manual, prior to assembly, setup, or use, in order to operate correctly and avoid damage or serious injury.
2. In some cases, the written instructions may differ slightly from the photos. In those instances, the written instructions should be considered correct.
3. This model is not a toy, rather it is a sophisticated remote control hobby product and must be operated with caution and common sense. This product requires some basic mechanical ability. Failure to operate this product in a safe and responsible manner could result in injury, or damage to the product, or other property.
4. This model must be assembled according to these instructions. Do not alter or modify the model outside of these instructions provided by Flex Innovations, LLC, as doing so may render it unsafe and/or unflyable. You must take time to build straight, true, and strong. It is your responsibility to ensure the air worthiness of this product.
5. Use only compatible, appropriate components for the final assembly of this model. Ensure that the radio system is in functional condition, that the engine is appropriately sized for the model and that all other components are appropriate for use in this model as specified in this instruction manual. All components must be installed correctly so that they operate correctly both on the ground and in the air.
6. Inspect and check the operation of the model and all its components before every flight.

7. If you are not an experienced pilot, or have not flown a high-performance model before, it is recommended that you seek assistance from an experienced pilot in your R/C club for your first flights. If you're not a member of a club, the Academy of Model Aeronautics (AMA) has information about clubs in your area whose membership includes experienced pilots.
8. Keep the propeller area clear from such items as loose clothing, jewelry, long hair, or tools, as they can become entangled. Keep your hands and body parts away from the propeller as injury can occur.

SPECIAL LANGUAGE DEFINITIONS

The following terms are used throughout the product literature to indicate various levels of potential harm when operating the product.

- NOTICE:** Procedures, which if not properly followed, create a possibility of physical property damage AND a liable or no possibility of injury.
- CAUTION:** Procedures, which if not properly followed, create a probability of physical property damage AND a possibility of serious injury.
- WARNING:** Procedures, which if not properly followed, create the probability of property damage, collateral damage and serious injury OR create a high probability of serious injury.

IMPORTANT BEFORE ASSEMBLY

Carefully unpack your aircraft and inspect the parts. Review the manual and gather the required tools and supplies.

- Remove all parts from their plastic bags, inventory all items and closely examine all the major airframe components for damage. If any items are missing or you find damaged components, do not proceed. Please contact customer support.
- Your aircraft has experienced many changes in temperature, density, etc. Throughout its transit from the factory, warehouse, and finally to your location. It is expected that some areas of covering will show wrinkles
- Use a covering iron with a covering sock on high heat to tighten the covering as necessary, paying special attention to the leading edges of the flying surfaces, hinge lines and stabilizer and wing saddle areas. Apply slight pressure over sheeted areas to thoroughly bond the covering to the wood. Use caution around seams to prevent inadvertently pulling them loose.
 - **Pro-Tip:** You can use a "Seal-It Pen" or clear nail polish to permanently seal any sharp edges or corners of covering that may come loose in flight.
- Use thin CA to go over any important glue joints, such as the motor box, firewall, servo mounting rails and any other pre-assembled joints that may see high stress during flight.
- Gather all the required components such as motor and radio equipment that will be used to equip the airplane. Create a new radio program in your transmitter and bind this model program to the receiver that will be used in the airplane
- Glass cleaner and paper towels work well to clean your airframe. For an additional shine, spray wax is an option.
- It is a good idea to have some isopropyl alcohol on hand throughout assembly. This can be used to help clean residual adhesives.

AIRFRAME ASSEMBLY

RUDDER CONTROL HORN INSTALLATION

Required for this section

Components

- Rudder Control Horns (set of 2)
- Rudder Control Horn Base (1)

Tools

- Hobby Knife with a #11 blade

Adhesives/Building Materials

- Isopropyl Alcohol
- 30-minute Epoxy
- Paper Towels
- Toothpicks
- Mixing Cups
- Mixing Sticks (something to mix epoxy with)

Note: The Edge540 120cc G2 features pre-installed control horns for the ailerons and elevators. The only control horns that need to be installed are on the rudder. The servo and the control horn can be installed on either side of the fuselage, just ensure that you cut openings for both on the same side!

1. Scuff each control horn with medium grit sandpaper where it enters the control surface. Use a paper towel and isopropyl alcohol to clean up the control horn after it has been scuffed.



2. Slide the control horns through the square control horn base, and test fit them in their corresponding slots. Note that the holes in the control horn base are offset. This is so that the base does not extend over the hinge line. Adjust the holes in the control surfaces to fit the control horns if needed.



3. Apply epoxy to the control horn slots and control horn and insert the control horn into its corresponding slots. Double check the rudder control horn to ensure it is straight and seated properly. Use a paper towel and isopropyl alcohol to clean up any excess epoxy. Set the rudder aside and let the epoxy fully cure.

**Jase's Pro Tips:**

Use a ball link and the corresponding hardware to keep the two parts of each control horn aligned while the epoxy cures.

MAIN LANDING GEAR INSTALLATION

Required for this section

Components

- Fuselage Assembly
- Landing Gear
- Wheel Pants (L & R)
- Main Wheel (2)
- M6x25 Socket Head Cap Screw (4)
- M6 Flat Washer (8)
- M3x15 Socket Head Cap Screw (4)
- M3 Flat Washer (4)
- Landing Gear Axle (2)
- M5 Wheel Collar (4)

Tools

- 1.5mm Hex Driver
- 2.5mm Hex Driver
- 5mm Hex Driver
- 7mm Wrench
- 10mm Wrench
- 12mm Wrench
- Felt-Tipped Pen

Adhesives/Building Materials

- Blue Thread Lock
- Red Thread Lock
- Rubber Adhesive (e.g. GOOP)

Landing Gear Installation

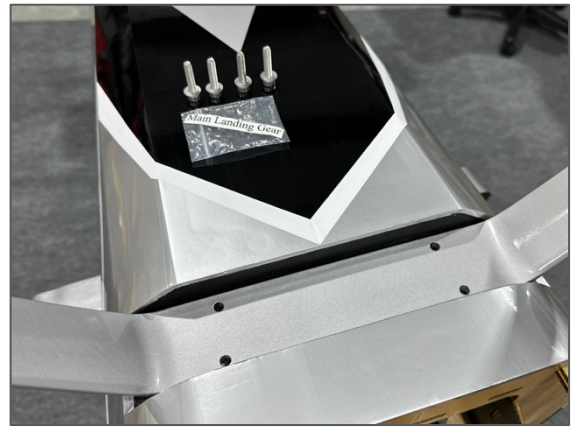

The landing gear is secured using four M6x25 bolts that thread from the bottom of the airplane into the blind nuts pre-installed in the fuselage.

1. Place the landing gear on the fuselage so that it sweeps forward and the wheels are closer to the nose of the airplane. The hole pattern is such that the landing gear can only be installed in one orientation.
2. Using blue thread lock, install the M6x25 socket head cap bolts with an M6 washer through each one of the holes in the landing gear and through the corresponding landing gear mounting hole in the fuselage. Tighten the screws using a 5mm hex driver loosely. Do not fully tighten until all four M6 screws are in place.

Landing Gear Cuff Installation

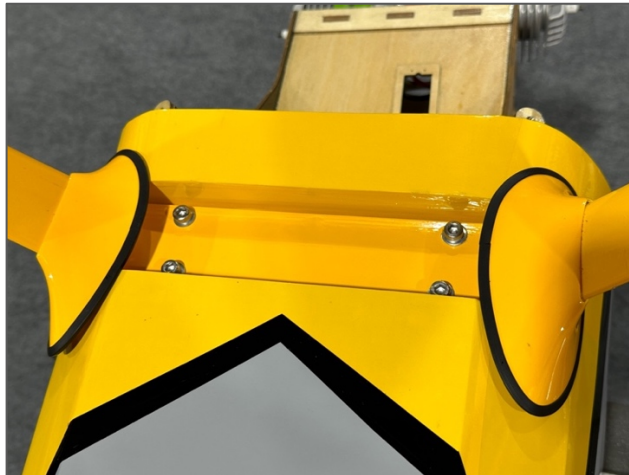

The landing gear cuffs are glued to the landing gear itself, and not the fuselage. This allows for easy removal of the landing gear.

1. Slide the gear cuff up into place against the fuselage. Apply a piece of masking tape at the bottom edge of the cuff on each side of the landing gear.



2. Slide the cuff back down and apply a bead of adhesive on each side of gear based on where you marked the bottom of the cuff. We recommend a rubberized adhesive such as GOOP.



- 3. Slide the gear cuff back up into place. Tape over the bottom of cuff to ensure no residual adhesive runs down the landing gear. Also tape the top of the cuff to the fuselage to keep it in place while the adhesive sets.



- 4. Keep airframe upright and allow the adhesive to cure for 24 hours (if using GOOP).

Wheel, Axle, and Wheel Pant Installation

The wheel, axle, and wheel pants feature a wheel pant saver system which will increase the longevity of the wheel pants when flying off grass runways for example.



- 1. Mount the axle to the landing gear by using the provided washer and locknut, use red thread lock on these nuts. Notice the flat spot on the end of the axle. To properly use the wheel pant savers, make sure this is facing towards the bottom of the airplane.



2. Put the wheel in place by sliding it over the axle. A collar will likely need to be installed to keep the wheel in place laterally.



3. Locate the wheel pant saver and mount it by aligning the set screw with the flat spot on the axle. Also thread the wood screws into the wooden piece of the wheel pant saver.



4. Dry fit the wheel pant in place and install the retaining bolts. Test fit the wheel pant saver by tightening the bolts. You may need to shave the wooden piece slightly to improve fitment.
5. Once fitment is confirmed, apply adhesive to the end of the wooden piece of the wheel pant saver. GOOP or E600 is recommended. Epoxy, for example, may be too brittle for this area.



- 6. Use blue thread lock, re-install and tighten the wheel pants for flight. Allow the adhesive to cure for at least 24



RUDDER AND TAILWHEEL INSTALLATION

Required for this section

Components

- Fuselage
- Rudder
- Rudder Hinge Wire
- Tail Gear Assembly
- Steering Ball Link (1)
- M3X16mm Socket Head Cap Screws (3)
- M3 Washers (3)

Tools

- 2.5mm Hex Driver
- Hobby knife

Adhesives/Building Materials

- Blue Thread Lock

Rudder Installation

The rudder is removable using a wire sliding through the hinges from the top.

1. Install the rudder by making sure the slots in the hinges are aligned. Also be sure, the bottom of the rudder lines up with the bottom of the fuselage.

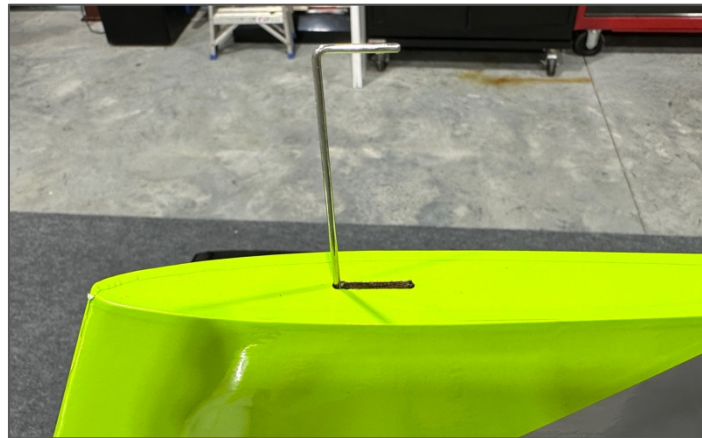

2. Run the wire through the top of the rudder through the hinges.
3. Press the top 90-degree bend of the rudder wire into the cutout on the top of the rudder.

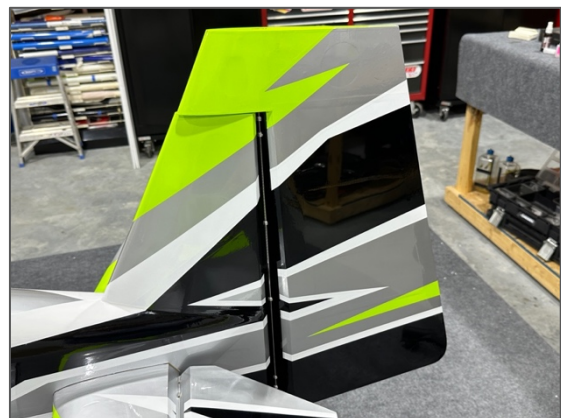

Rudder Servo Opening

1. Using a flashlight locate the opening for the rudder servo.
2. Double check that you are exposing the servo opening that is on the same side as the rudder control horn.
3. Once you have located the correct opening use a hobby knife with a sharp blade to remove the covering. You can cut the covering with an X shape and use a covering iron with a fine tip to seal the edges down to prevent the covering from lifting up in flight.

Tailwheel Installation

The tailwheel is mounted using three bolts along with a ball link.

1. Locate the hole in the bottom of the rudder that will accept the ball link for the steering arm. It is about 3-3/8 inches (85mm) aft of the rudder hinge line. Use a hobby knife with a #11 blade to remove the covering from the hole.

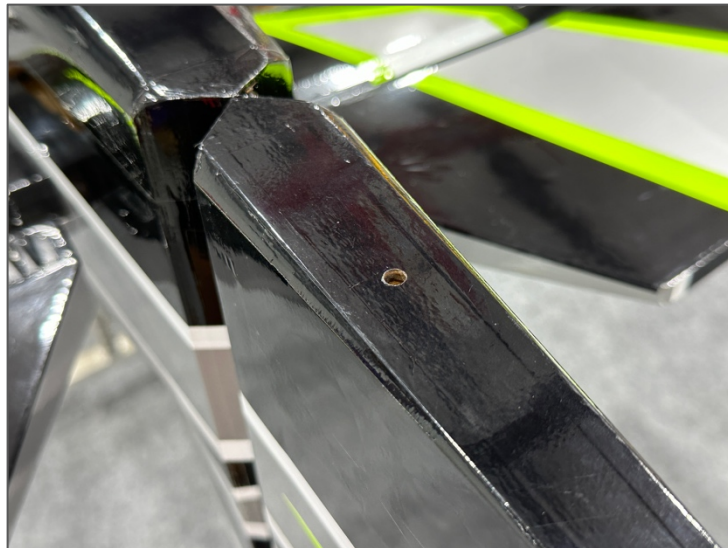

2. Scuff the cylindrical part of the ball link with a medium grit sandpaper. Clean the ball link with isopropyl alcohol and a paper towel to remove any leftover plastic particles.
3. Once clean and dry, apply adhesive and glue the steering ball link into the hole, keeping it square to the bottom of the rudder and perpendicular to the wire steering arm. Apply adhesive around the ball link for added strength.

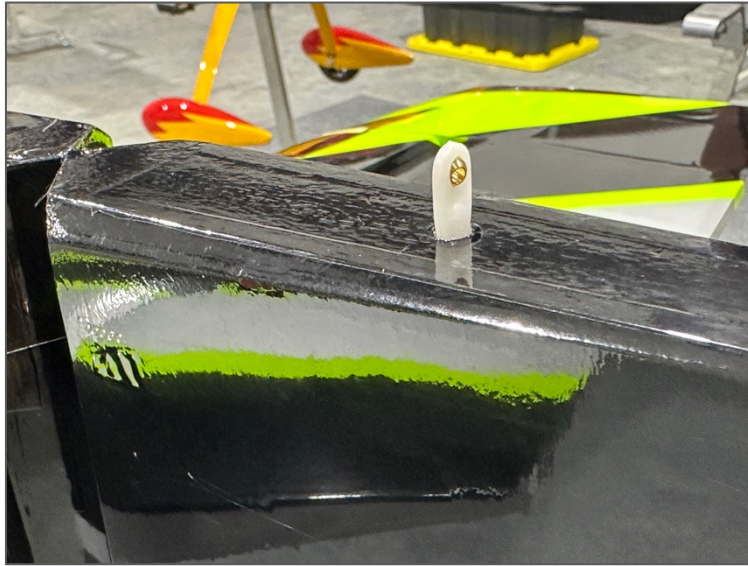

- 4. Once the adhesive is cured, slide the wire steering arm through the ball link and bolt the tail wheel mount in place using the supplied bolts and blue thread lock.



- 5. You can trim the steering wire leaving some overhang. Ensure that the steering wire stays on track within the ball link throughout the rudders full range of motion.

AILERON SERVO AND LINKAGE INSTALLATION

Required for this section

Components

- Main Wing Panels (2)
- Aileron Linkage (4)
- Aileron Servos (4)
- Aileron Servo Arms 1.5" (4)
- Tip Aileron Servo Extensions (2)
- Ball Links (8)
- M3x20 Socket Head Cap Screw (4)
- M3x15 Socket Head Cap Screw (4)
- M3 Washer (24)
- M3 Lock Nut (8)
- M3 Conical Spacer (4)

Tools

- 2.5mm Hex Driver
- 5.5mm Nut Driver
- #1 Phillips Screwdriver

Adhesives/Building Materials

- Thin CA
- Blue Thread Lock
- Heat shrink, dental floss or safety clips

1. Use a #1 Phillips screwdriver to thread a servo mounting screw into each of the pre-cut holes in the servo mounting rails in the wing. Remove the screw and apply a small amount of thin CA to each of the holes to harden the threads cut by the screw. Do not use CA accelerator. Let the CA fully cure before moving forward.
2. Assemble your servo grommets per your servo manufacturer's instructions.

Jase's Pro Tip:

Many servo grommet brass eyelets will fit over most hex drivers. Slide all the eyelets over the hex driver, flared end first. Use the hex driver to push the eyelets into the servo grommets one right after the other for easier installation.

3. Secure a servo extension to each of the two tip aileron servos. Use servo connector safety clips (FPZA1040), heat shrink or dental floss to secure the extension.
4. Insert the aileron servo into the servo bay with the output shaft towards the **trailing edge** of the wing. Be sure to route the servo lead out of the wing before mounting the servo. There is string routed through the wing to assist you in pulling the tip aileron servo extension through the wing. Mount the servo to the wing using the servo mounting screws provided with your servos.
5. Using an aileron pushrod, assemble the aileron linkages so that the total length from center of ball to center of ball is approximately 3-1/2 inches (89mm). Final length will be adjusted when centering the control surface. Note that one end of each aileron linkage has left-hand threads, while the other end has right hand threads, this will allow for adjusting the linkage length without removing either end of the linkage.

Jase's Pro Tip:

Use a set of digital calipers to measure the length of threads exposed on each end of the linkage. This allows you to ensure that the ball links are equally threaded onto each end of the linkage.

6. Attach the linkage to the servo arm. The correct hole location is 1 ½ inches (38mm) from center. If using the recommended 1 ½ inch servo arm, this is the hole at the end of the

servo arm. The order of hardware components, starting from the top of the servo is as follows:

- M3x20 socket head cap screw
 - M3 washer
 - Ball Linkage
 - Conical Spacer (narrow, pointed side towards the ball link)
 - Servo Arm
 - M3 washer
 - M3 locknut
7. Use your radio system power on the servos to center them. Install your aileron servo arm onto the servo as close to parallel with the hinge line as possible. Apply blue thread lock to the servo arm output shaft screw and fully tighten the screw. If your servo arms have clamping screws, apply blue thread lock, and secure them in place as well. Once complete, use sub-trim to fine tune the center position of the servo to be perfectly parallel to the hinge line.



8. With the radio powered-on and the servo arm parallel to the hinge line, connect the root aileron servo linkage to the control horn with the hardware in the following order:
- M3x15 Socket Head Cap Screw
 - M3 Washer
 - Control Horn (Side 1)
 - M3 Washer
 - Ball Link
 - M3 Washer
 - Control Horn (Side 2)
 - M3 Washer
 - M3 Lock Nut
9. Center the aileron by lengthening or shortening the linkage as needed.



Note: The angle of the linkage when centered is correct. As the servo arm rotates and the control surface deflects, the linkage will straighten.

- 10. Once the root aileron servo is connected, set your end points in both directions so that the ailerons travel 38 degrees up and 37 degrees down, at the root of the aileron, when set to high rates. Once complete, center the tip servo, and adjust the linkage so that there is no binding with the tip root at neutral. Deflect the servos to maximum and adjust the tip servo end points to match the root servo in both directions. Once satisfied with the matching of the servos, attach the linkage to the control horn using the same order of components used previously.

Jase's Pro Tip:

When matching the tip servo to the root servo, don't connect the linkage to the control horn of the tip servo. Instead, place the ball link in the control horn, and use a bolt, or hex driver with a 3mm shaft, to check the alignment of the hole in the control horn and the hole in the ball link. If it slides easily through the hole, its aligned. If not, you still need to adjust the servo travel.

- 11. For the wing servos, the Dual Servo MPX Connector (FPZA1066) is an easy way to route both servos to the receiver. The fuselage has a slot specially designed to mount the MPX connector.

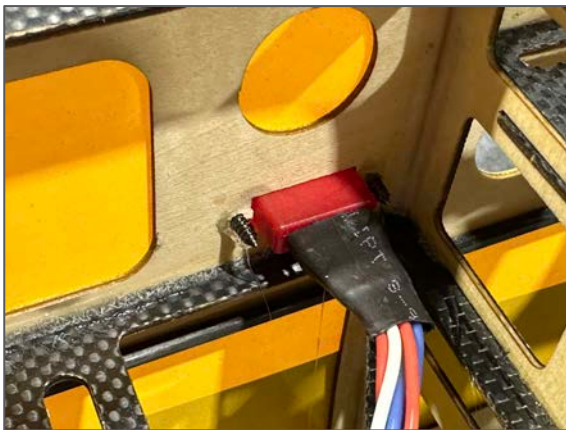

- 12. Be sure the leads of the connector are secured within the wing to help prevent them from coming unplugged.

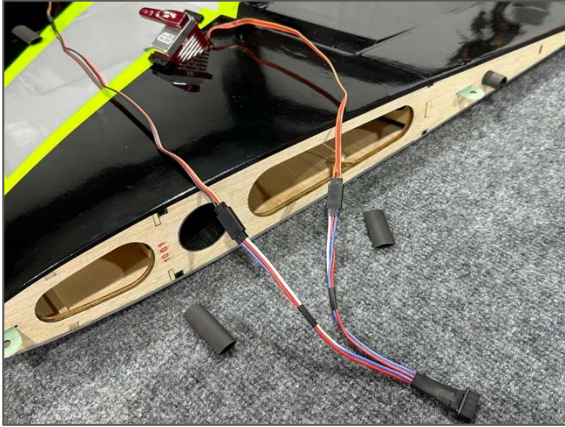

ELEVATOR SERVO AND LINKAGE INSTALLATION

Required for this section

Components

- Left and Right Horizontal Stabilizers (2)
- Elevator Servos (2)
- Elevator Servo Arm 2" (2)
- M3x20 Socket Head Cap Screw (2)
- M3x15 Socket Head Cap Screw (2)
- M3 Washer (12)
- M3 Lock Nut (4)
- M3 Conical Spacers (2)

Tools

- 2.5mm Hex Driver
- 5.5mm Nut Driver
- #1 Phillips Screwdriver

Adhesives/Building Materials

- Thin CA
- Blue Thread Lock
- Dental Floss, Heat Shrink or Safety Clips

1. Use a #1 Phillips screwdriver to thread a servo mounting screw into each of the holes in the servo mounting rails in the horizontal stabilizer. Remove the screw and apply a small amount of thin CA to each of the holes to harden the threads cut by the screw. Do not use kicker, allow the CA to fully cure before moving forward.
2. Assemble your servo grommets per your servo manufacturer's instructions.



3. Insert the elevator servo into the mounting location with the output shaft towards the leading-edge of the stab. Mount the servo to the stab using the mounting screws provided with your servo. Note that the servo wire will exit on the leading-edge side of the stab as shown in the picture above.
4. Power on your radio system to center the servo. Install a 2-inch (51mm) servo arm onto the servo as close to perpendicular with the servo's case as possible. Apply a small amount of blue thread lock to the servo arm screw and secure it in place. If your servo arm has clamping screws, apply blue thread lock to these screws and secure them in place. Note that you may need to power off the model and rotate the servo arm by hand

to have access to each clamping screw. Use sub-trim to set the servo arm perfectly perpendicular before installing the elevator.

- 5. Using an elevator pushrod, assemble the elevator linkages and ball links so that the total length from center of ball to center of ball is approximately 3 ¼ in (83mm). Final length will be adjusted when centering the control surface. Note that both ends of the elevator linkages have opposite direction threads.
- 6. Attach the linkage to the servo arm. The correct hole location is 2-inches (50.8mm) from the center of the servo. If you are using the recommended servo arm this is the hole at the end of the servo extension arm. The order of hardware components, starting from the top of the servo is as follows:
 - M3x20 socket head cap screw
 - M3 washer
 - Ball Linkage
 - Conical Spacer (narrow, pointed side towards the ball link)
 - Servo Arm
 - M3 washer
 - M3 locknut

Note: There is a conical spacer supplied with the linkage hardware.

- 7. Attach the linkage to the control horn. The order of hardware components, starting from the tip of the stabilizer is as follows:
 - M3x15 socket head cap screw
 - M3 washer
 - Control Horn #1
 - M3 washer
 - Ball Linkage
 - M3 washer
 - Control Horn #2
 - M3 washer
 - M3 locknut

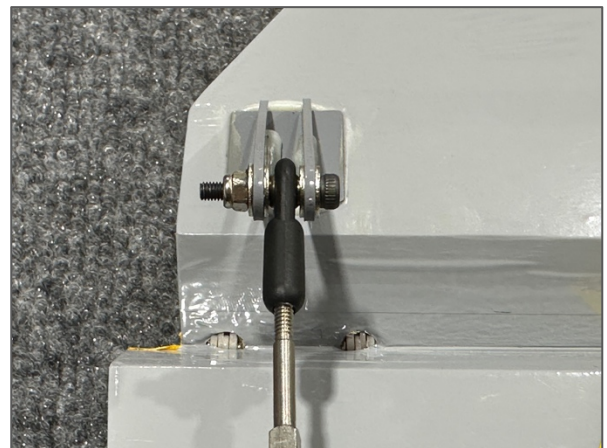
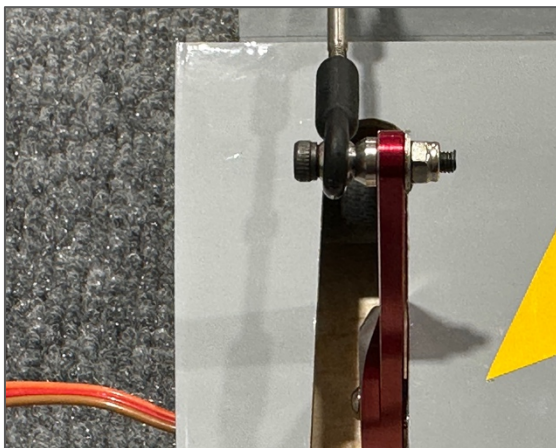

- 8. With the radio powered on and the servo arm centered perpendicular to the servo case, adjust the linkage length so that the control surface is centered.

Quique Pro Tip:

- For elevator centering, it is best to install the stabilizers onto the fuselage and stand approximately 10 feet (3m) behind the aircraft while sighting the two elevator halves. Using this method, you can best align the most important part of the control surface, the wider section, rather than referencing something less important, like the elevator counterbalance.

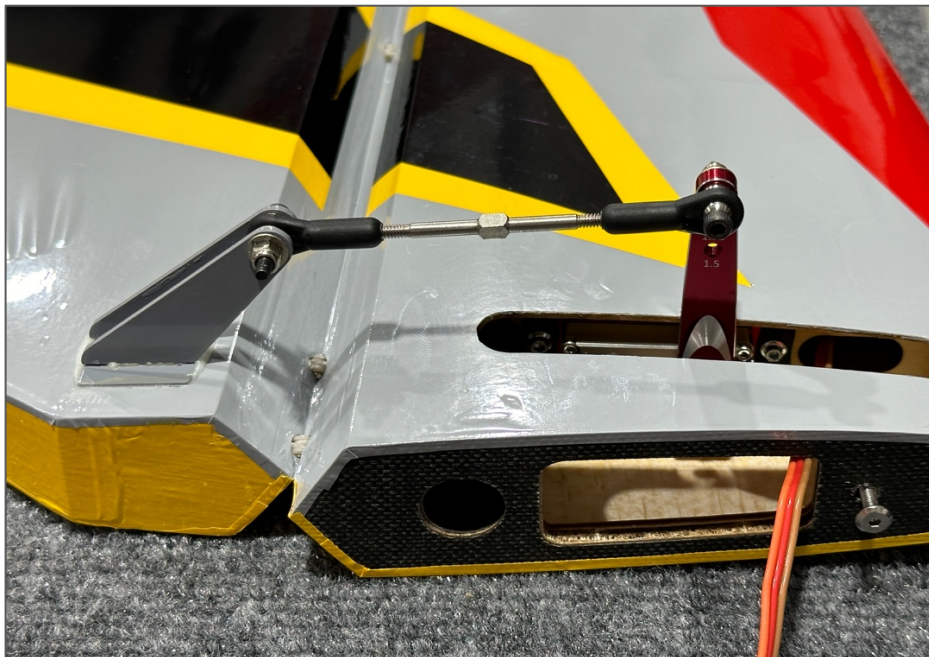

9. After installation is complete, your linkage setup should match the image above. Repeat the same procedure for the other horizontal stabilizer.

RUDDER SERVO AND LINKAGE INSTALLATION

Required for this section

Components

- Fuselage Assembly
- Rudder Servo
- Rudder Servo Arm 2" (2)
- Rudder Servo Extension (1)
- Elevator Servo Extensions (2)
- M3x20 Socket Head Cap Screw (1)
- M3x15 Socket Head Cap Screw (1)
- M3 Washer (6)
- M3 Lock Nut (2)
- M3 Conical Spacer (1)

Tools

- 2.5mm Hex Driver
- 5.5mm Nut Driver
- #1 Phillips Screwdriver

Adhesives/Building Materials

- Thin CA
- Blue Thread Lock
- Dental Floss, Heat Shrink or Safety Clips

1. Use a #1 Phillips screwdriver to thread a servo mounting screw into each of the holes in the servo mounting rails in the horizontal stabilizer. Remove the screw and apply a small amount of thin CA to each of the holes to harden the threads cut by the screw. Do not use kicker, allow the CA to fully cure before moving forward.
2. Assemble your servo grommets per your servo manufacturer's instructions.
3. Secure a servo extension to the rudder servo. Use servo connector safety clips (FPZA1040), heat shrink or dental floss to secure the extension.
4. Feed the rudder servo extension and the two elevator servo extensions through the tube in the fuselage that is provided for this purpose. Secure the extensions to prevent excessive movement during flight.
5. Insert the rudder servo into the mounting location you exposed, with the output shaft towards the rear of the fuselage. Mount the servo to the fuselage using the mounting screws provided with your servo.
6. Power on your radio system to center the servo. Install a 2-inch (51mm) servo arm onto the servo, pointing down, as close to perpendicular with the servo's case as possible. Apply a small amount of blue thread lock to the servo arm screw and secure it in place. If your servo arm has clamping screws, apply blue thread lock to these screws and secure them in place.
7. Using an elevator pushrod, assemble the elevator linkages and ball links so that the total length from center of ball to center of ball is approximately 3 ¼ in (83mm). Final length will be adjusted when centering the control surface. Note that both ends of the elevator linkages have opposite direction threads.
8. Attach the linkage to the servo arm. The correct hole location is 2-inches (50.8mm) from the center of the servo. If you are using the recommended servo arm this is the hole at the end of the servo extension arm. The order of hardware components, starting from the top of the servo is as follows:

- M3x20 socket head cap screw
- M3 washer
- Ball Linkage
- Servo Arm
- M3 washer
- M3 locknut

Note: There is a conical spacer supplied with the elevator linkage hardware. If using the recommended servo and servo arm, this spacer is not needed. If using a different brand of servo or servo arm, you may need to use this spacer to keep the linkage perpendicular to the hinge line. Most of the time, it is not needed.

9. Attach the linkage to the control horn. The order of hardware components, starting from the tip of the stabilizer is as follows:

- M3x15 socket head cap screw
- M3 washer
- Control Horn #1
- M3 washer
- Ball Linkage
- M3 washer
- Control Horn #2
- M3 washer
- M3 locknut



10. With the radio powered on and the servo arm centered perpendicular to the servo case, adjust the linkage length so that the control surface is centered.



11. After installation is complete, your linkage setup should match the image above.

GAS POWER SETUP

FUEL TANK INSTALLATION

Required for this section

Components

- Fuselage Assembly
- Fuel Tank
- Fuel Line
- Fuel Filler

Tools

- Pliers

Adhesives/Building Materials

- Hook and Loop Strap (2)
- Adhesive-Back Hook and Loop Tape
- Cable Ties

The Flex Innovations 32oz Lightweight Fuel Tank is included with your Edge 540 120cc G2.

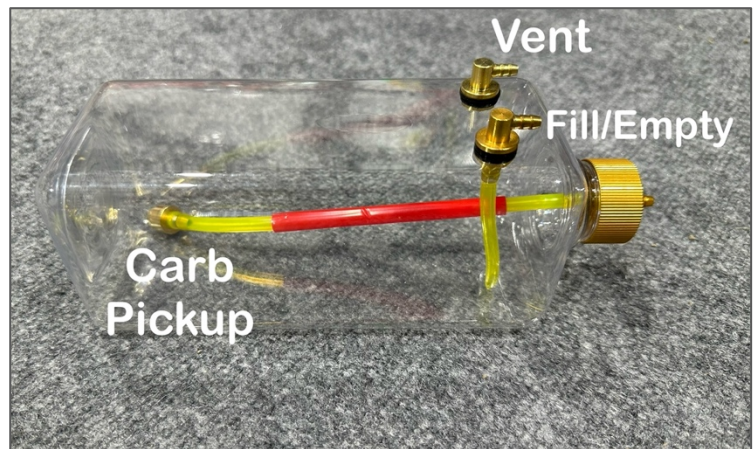
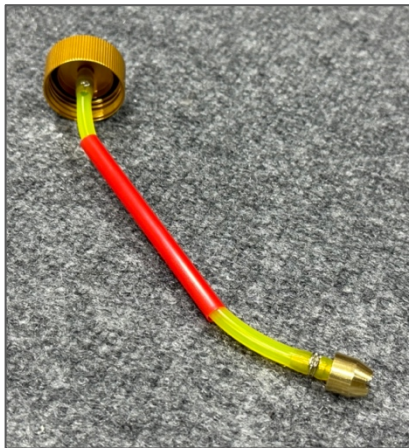

- 1. Assemble your fuel tank. Before installing the fuel tank check all fittings are properly installed and that the clunk line inside the tank is appropriately sized. Adjust as necessary. We recommend using a straw around the pickup line inside the tank as shown above, this will prevent the line from wrapping around itself during flight.

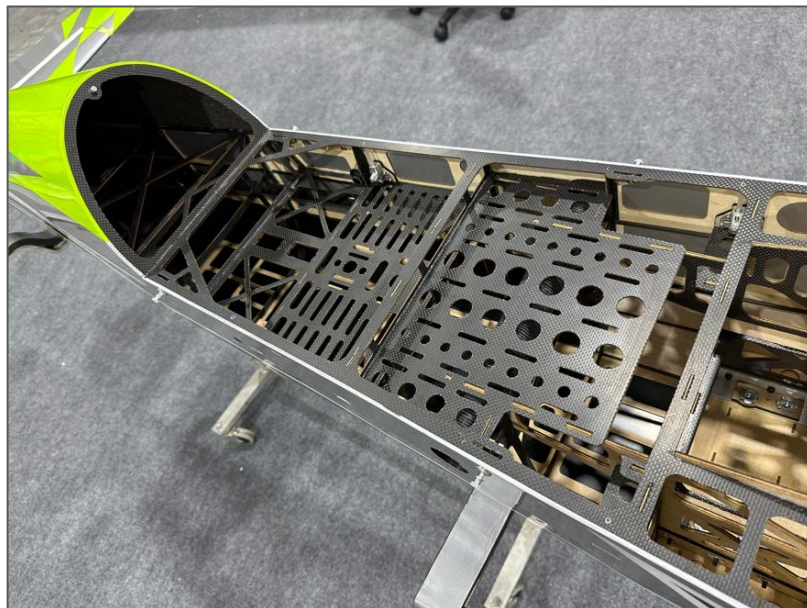

2. As shown in the picture on the previous page, the fuel tank tray has plenty of room for your fuel tank. If you are using a single tank, you can place the fuel tank in the middle of the tray. If you plan on using a smoke system, two of the 32oz Lightweight Fuel/Smoke tanks (FPM1623) should be used, installed side by side. One is included in your kit. Both tanks should be center over the wing tube in order to be closer to the airplane's CG.

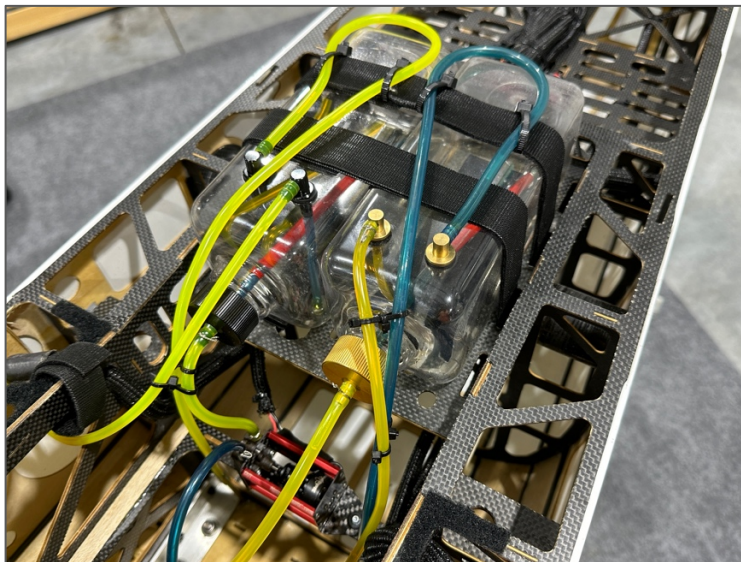

3. To mount the tank(s), apply adhesive-backed hook and loop tape to the bottom of your tank(s) and to the fuel tank tray. Place the tank(s) in their location and secure them with two hook and loop straps. These straps should be snug but not overly tight, as the fuel tanks are very lightweight and can be easily crushed. The hook and loop tape on the bottom of the tank(s) will prevent the tank from moving fore and aft, and the hook and loop straps will prevent the tank from pulling away from the tray.

Jase's Pro Tip:

Wrap the vent line(s) around the top of the fuel tank(s) all the way to the back and then return to the front of the tank(s) to prevent siphoning.

Tie wire is a good way to keep all fuel line connections secure. You can also use a small ring of Tygon tubing as a clamp.

4. After the tank is in position, route and trim your fuel lines appropriately. Your clunk line should go to the carburetor or throttle body. The fill line should go to your fuel dot or filling system. We recommend the McFueller Fuel Dot (FPMA1049).



5. The vent line should warp around the tank and should then exit the bottom of the fuselage. After the vent line exits the fuselage. A piece of metal tubing coming from the bottom of the airplane can be used for vent. Or the vent line can be run through the bottom of the fuselage and secured with a zip tie. Don't overtighten the cable tie, as air and fuel will need to vent from this line. Be sure to keep your fuel line away from components that get hot (like your exhaust or cylinder heads) and route it in such a way that it will not bounce around or chafe on any of the interior structure of the fuselage.



ENGINE INSTALLATION

Required for this section

Components

- Fuselage Assembly
- Engine
- Engine Standoffs (15mm)
- ¼-20 Blind Nut (4)
- ¼-20 x 1¾-inch Socket Head Cap Screw (4)

Tools

- Drill
- ⅛-inch (3mm) Drill Bit
- ¼-inch (6.5mm) Drill Bit
- ¼-inch Hex Driver

Adhesives/Building Materials

- Blue Thread Lock
- Thin CA

Mount the Engine

- 1. The engine mounting location for the DA-120 and GP-123 is laser-etched into the firewall for your convenience. If you will be using an engine with a different mounting pattern, the "+" represents the engine crankshaft. Use a ⅛-inch drill bit and drill to create a pilot hole in the center of the four bolt hole etchings in the firewall. Use a ¼-inch drill bit to enlarge these holes to the appropriate size for the engine mounting bolts. There is also a laser etching for the throttle linkage just below the lower right mounting hole (when looking at the firewall from the front). You can open this hole at this time as well if using the DA-120. Other engines may require a different hole location.

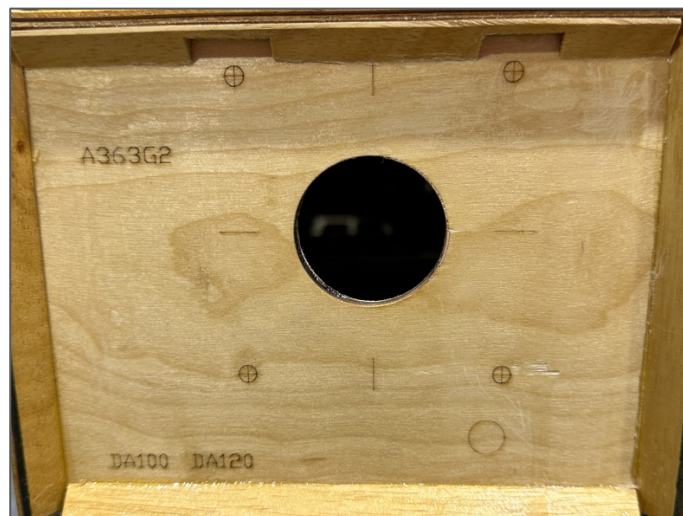

- 2. Mount the engine (without the exhaust) to the firewall using (4) 20mm engine standoffs, (4) ¼-20 x 1¾-inch socket head cap screws, (4) ¼-inch flat washers, (4) fender washer and (4) ¼-20 Lock Nuts.

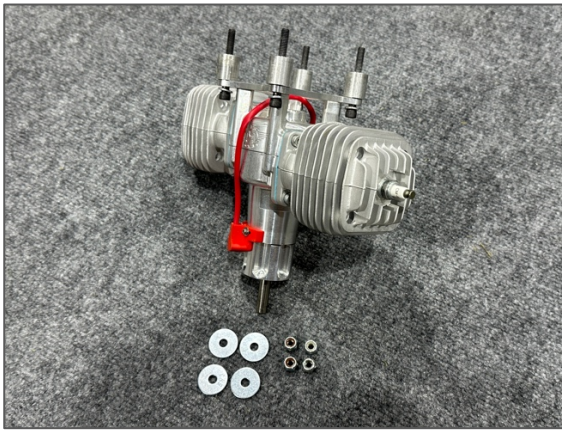

DA-120 Throttle Servo and Linkage Installation

Required for this section

Components

- Fuselage Assembly
- Throttle Servo
- 9-inch (230mm) Servo Extension
- Throttle pushrod
- 2mm Ball Link (2)
- M2x10 Phillips Head Screw (2)
- M2 Flat Washer (4)
- M2 Lock Nut (2)

Tools

- #1 Phillips Screwdriver
- 2.5mm Hex Driver

Adhesives/Building Materials

- Thin CA
- Blue Thread Lock
- Heat Shrink, Dental Floss or Safety Clips

1. Thread a servo mounting screw into each of the four mounting screw holes in the motor box. Apply thin CA to each of the holes to harden the threads.

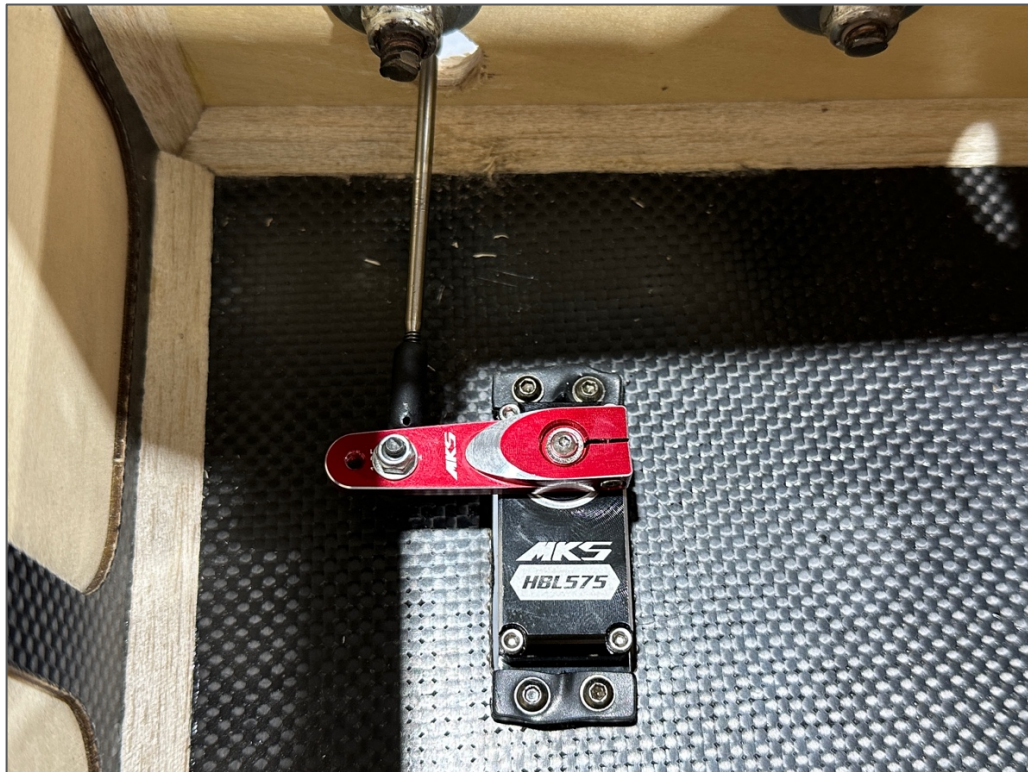

2. Attach the 9-inch (600mm) servo extension to the throttle servo. Use a Servo Connector Safety Clip (FPZA1040), thread or heat shrink tubing to secure the extension in place. Mount the servo with the output shaft towards the motor and route the servo extension appropriately through the aircraft.
3. Assemble the throttle linkage and install a 1" servo arm. If your arm is longer, use the 1" location on the arm.
4. Use an M2x10 socket head cap screw, M2 washers, and M2 lock nut to secure the ends of the linkage to the throttle arm on the carburetor and to the servo arm. The order of components is as follows:
 - M2x10 Socket Head Cap Screw
 - M2 Washer
 - Throttle Arm/Servo Arm
 - M2 Lock Nut
5. Adjust the length of the throttle linkage so that both the throttle arm and servo are in the exact center location when your throttle stick is centered. Set your end-points to achieve full range of motion and to avoid binding at either end-point.

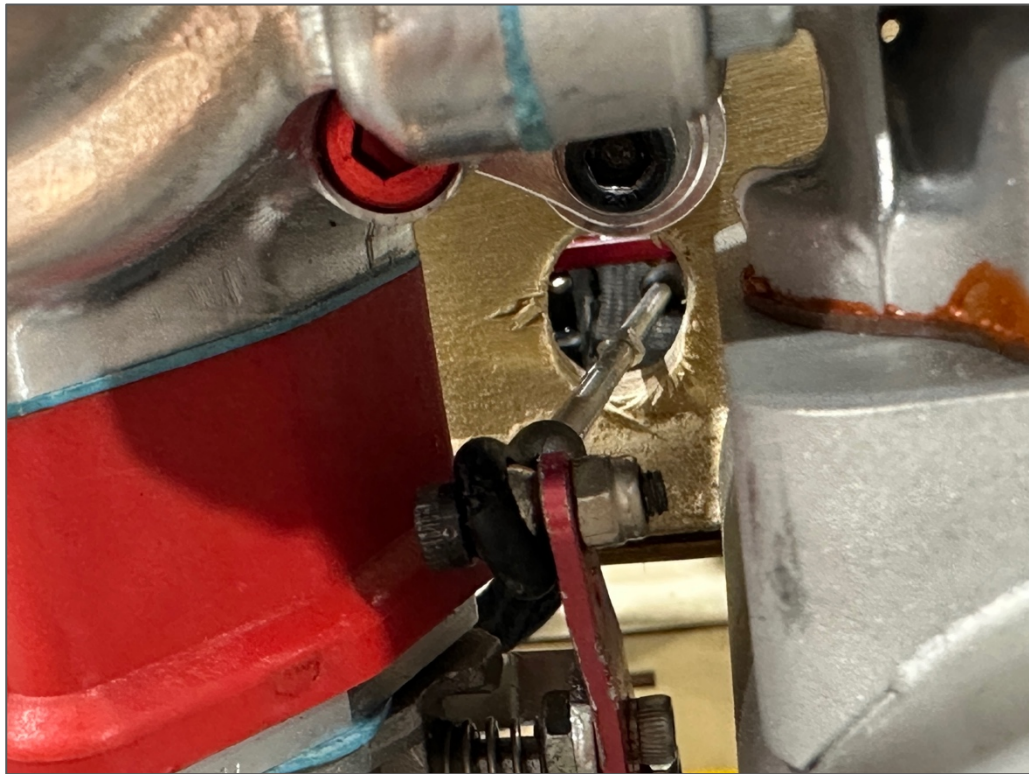

Jase's Pro Tips:

- Use the shortest servo arm possible while still getting full throttle arm movement on your engine. Your throttle end points should be around 110-120% when finished with the installation. A faster servo (like the Potenza DS49010HV) with a shorter arm is preferred over a slower servo with a longer arm.
- For the most linear throttle response, adjust the throttle linkage length to balance the end points for your throttle servo. You do NOT want your end points to be mismatched (example: 60/120). Set your end points as close to one another as possible (example: 114/116) for the most linear throttle response.

IGNITION INSTALLATION

Required for this section

Components

- Fuselage Assembly
- Ignition
- Ignition Switch
- Ignition Battery or IBEC
- Regulator (if applicable)
- (4) M2.5 x 8mm Wood Screws
- Motor box access hatch

Tools

- Hobby Knife w/#11 Blade
- #1 Phillips Screwdriver

Adhesives/Building Materials

- Hook and Loop Strap (2)
- Adhesive-Back Hook and Loop Tape
- Thin CA

1. Locate the ignition switch hole towards the nose of the fuselage. Note that there are switch locations on both sides of the fuselage for your preference. Use a hobby knife with

a #11 blade to remove the covering from the hole of your choice. Test fit your switch and modify the hole if needed. Secure it in place using the screws included with your switch. If your switch mounting screws thread into metal, be sure to apply blue thread lock. **DO NOT** apply blue thread lock if they thread into plastic.

- 2. The ignition can be mounted wherever you prefer. We have found that with the DA-120, the inside of the motor box or the motor box hatch is our preferred location. There are many ways to install an ignition and we recommend you mount it per your engine manufacturer's recommendations.

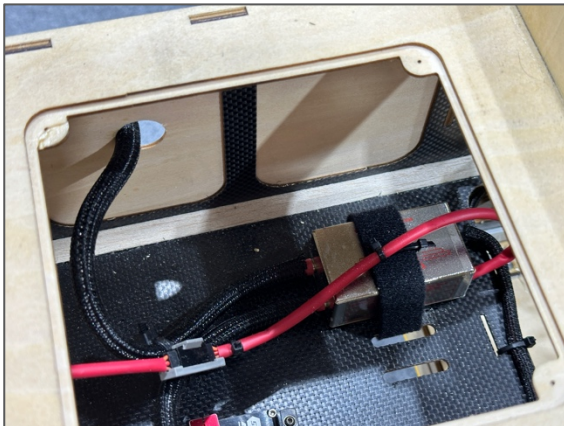

- 3. If you are using an ignition battery, we recommend using a 2S 2000mAh Li-Po (FPZBR20002S15) placed in the motor box in the provided location next to the ignition module that is accessible from the main hatch. Use adhesive-backed hook and loop tape between the battery and the hatch and secure the battery with a hook and loop strap. For this installation we are showing a battery eliminating ignition switch from Desert Aircraft.

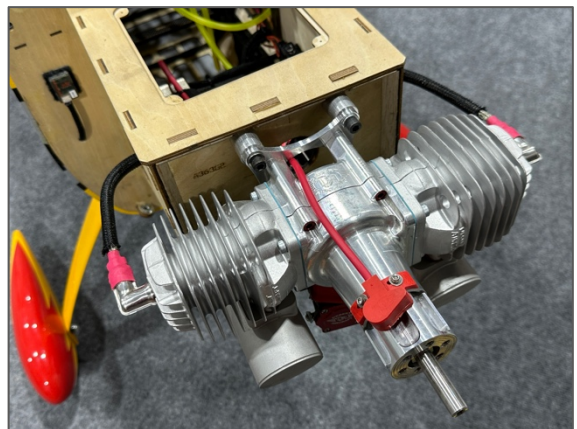
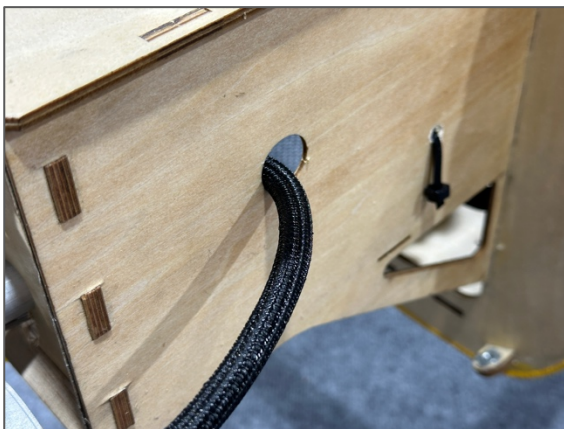

- 4. If installed in the motor box, route the ignition plug wires through the holes on the sides of the motor box.
- 5. Secure any permanent connections with heat shrink dental floss or servo safety clips (FPZA1040). Be sure to secure the wiring so that it will not bounce around in the aircraft. For extra security we recommend that you wrap your ignition wiring, also, be sure to secure the wiring in a way that the wires will not chafe against sharp edges from vibration. A typical ignition setup will be connected as follows:

Ignition Battery → Ignition Switch → Ignition Regulator → Ignition → Engine

Or (if using an IBEC):

Receiver Channel → IBEC → Ignition → Engine

- 6. Thread a wood screw into each of the four access hatch screw holes in the motor box. Apply thin CA to each of the holes to harden the threads
- 7. Use the (4) wood screws to secure the motor box access hatch in place.

EXHAUST AND COWLING INSTALLATION

Required for this section

Components

- Fuselage Assembly
- Cowling
- Cowling Baffles
- Your Exhaust Choice
- Canister or Pipe Mount
- Exhaust marking template

Tools

- Rotary Tool
- Rotary Tool Sanding Drum
- Rotary Tool Cut-Off Wheel
- Felt-Tipped Pen
- Covering Iron
- 2.5mm Hex Driver

Adhesives/Building Materials

- Thin CA
- CA Accelerator
- Blue Thread Lock
- Red Thread Lock
- 30 Min Epoxy
- Mixing Cups
- Mixing Sticks
- Paper Towels

If you plan to use stock mufflers, please follow the instructions (A) below. If you plan on using a canister exhaust setup, please follow the canister installation (B) instructions starting on page 37. Be sure to follow the engine baffling instructions for both setups. Different engines and exhaust setups may require significantly different installations. You will need to decide what is best for your setup.

Muffler Installation (A)

- 1A. If using stock mufflers, locate the two bolts for each muffler, lock washers, and the gaskets. We recommend that you temporarily cover the carburetor opening while installing the mufflers and the cowling to prevent any debris from accidentally entering it and harming your engine.
- 2A. Apply a moderate layer of RTV silicone (Permatex Ultra Copper recommended) to the muffler port on the engine followed by placing the gasket.



- 3A. Apply red thread lock to the muffler bolts and install the mufflers.
- 4A. The Edge 540 120cc G2 features a clear cowling template for simple exhaust hole mapping.
- 5A. Pre-fit the template by aligning it to the cowling itself and mark where the cowling bolts align to the template. Cut holes for the bolts and bolt the template to the fuselage.

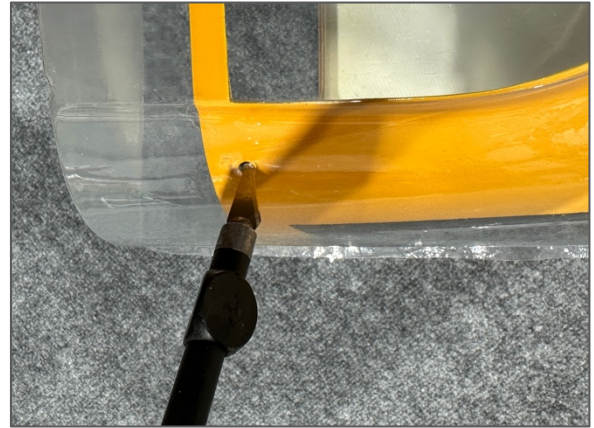

- 6A. Mark where the exhaust needs to be relieved through the template.

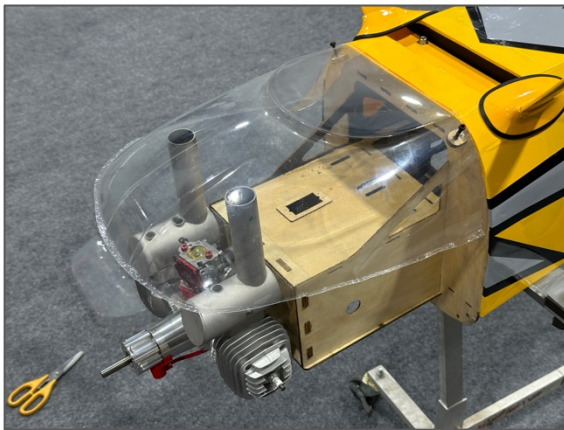

- 7A. Cut the holes out of the template, and bolt to the cowling itself. Transfer your marking to the cowling
- 8A. The holes can then be cut from the cowling using a Dremel tool. Test fit the cowling and slowly open the exhaust openings until the cowling fits properly. You can then clean the edges of the openings.

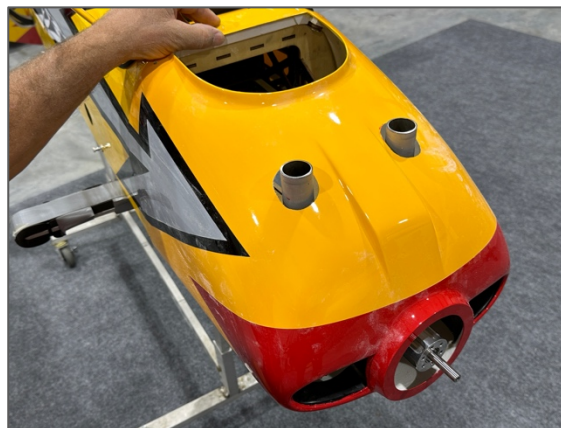

Canister Installation (B)

Required for this section

Components

- Fuselage Assembly
- 2-to-1 Exhaust Header
- Canisters
- Exhaust Gaskets (2)
- Canister Mount Plate
- Silicones Tubes

Tools

- 4mm Driver
- 2.5mm Hex Driver
- #11 Exacto Knife

Adhesives/Building Materials

- Red Silicone (RTV)
- Paper Towels

There are an extraordinary number of possible engine and exhaust combinations that we can't completely cover in this manual. This section will cover the typical setup as recommended at the beginning of this manual.

- 1B. Assemble your header and canister or pipe per your exhaust manufacturer's recommendations and select a canister or pipe mount that fits your exhaust. Assemble the silicone tubing into the mount if needed. Included with the Edge 540 120cc is a mount for 60mm diameter exhausts, like the KS 3086 canister. If your exhaust is a different size, you'll need to make one or get one from your exhaust or engine supplier.

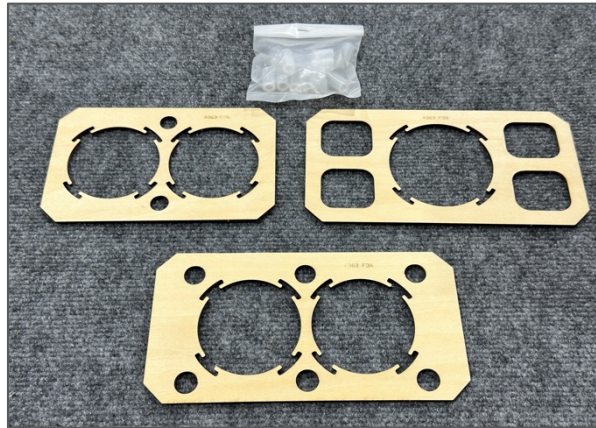

- 2B. Temporarily insert your exhaust into the fuselage to locate where the exhaust should exit the bottom of the fuselage. Mark or note the area of the fuselage bottom plate and/or covering that needs to be removed and remove the exhaust from the aircraft. The KS 3086 canister should exit in the opening just aft of the main wing tube.

There are a few sections where you may not need to remove wood, but if you find it necessary to remove material, only remove the areas noted with black hash marks below. Do not remove any additional material other than what is needed.

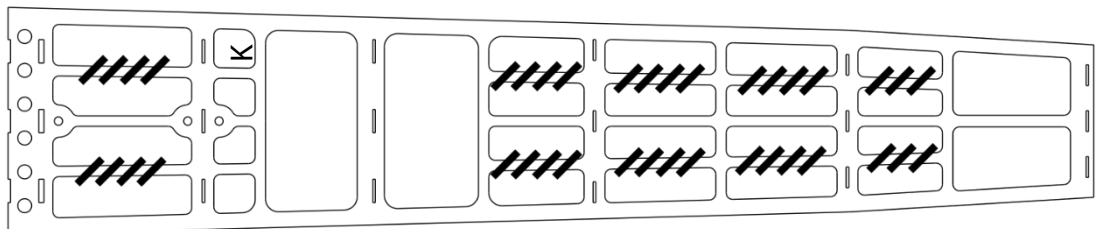

- 3B. Re-insert your exhaust into the fuselage and slide your canister mount over the exhaust. Decide the location that best suits your mount. For the provided mount and the KS 3086 canister, the optimum location is against the rear of the F2 former, located just aft of the landing gear mounting brackets.
- 4B. Mix an adequate amount of epoxy and glue the mount to the former decided upon in the previous step. You can use servo screws to secure the mount in place while the epoxy cures if desired.

Engine Baffling and Cooling Installation

Required for this section

Components

- Fuselage Assembly
- Cowling
- Cowling Baffles
- Cooling Plates
- (4) M2.5 x 8mm Wood Screws

Tools

- Ruler
- Hobby knife

Adhesives/Building Materials

- GOOP or other flexible adhesive
- Thin CA
-

The Edge 540 features pre-molded fiberglass baffling for effective operation and easy installation.

- 1. The Edge 540 features pre-molded fiberglass baffling for effective operation and easy installation.
- 2. Fit the baffles in place by aligning the shape of each baffle along with the offset of the engine cylinders based on the baffle depth. Tack in place with CA.
- 3. Test fit the cowling with the baffles to make sure fitment is proper. Depending on your engine, you may need to trim the baffles slightly.
- 4. Once fitment is confirmed, use GOOP to permanently mount in place.



- 5. The Edge 540 includes fuselage plates installed on the bottom for can/tuned pipe use and air venting even with a stock muffler setup.



- 6. To install these plates, remove the covering where the plate provisions are located. Each plate is installed using four wood screws. Be sure to apply thin CA after the openings are threaded to prevent stripping.

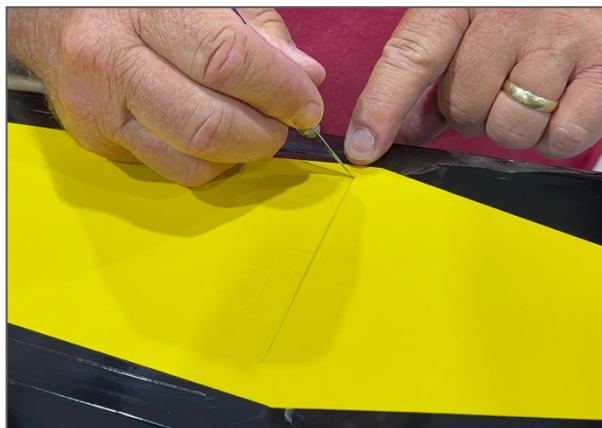

- 7. The cowling has a pre-cut pressure lip opening for hot air exit. Additionally, there is an opening in the cowl for easy choke access and proper airflow.



COWLING, PROPELLER AND SPINNER FINAL INSTALLATION

Required for this section

Components

- Fuselage Assembly
- Cowling
- Propeller
- Spinner
- (4)M4x20 Socket Head Hex Bolt
- (4) M4 Washer

Tools

- M3 Hex Driver
- M2 Hex Driver (Spinner)

Adhesives/Building Materials

- Blue Thread Lock

The cowling is installed with four total bolts. Two bolts are accessed through the inside of the fuselage, and two are accessed on the bottom of the cowling.

The Edge 540 120cc G2 takes a 5" spinner. Flex offers matching spinners for the Edge 540 120cc G2 schemes along with solid color spinners.

1. The cowling is installed with (2) M4x20 hex bolts with M3 washers at the top installed from the inside of the fuselage with the main hatch removed and (2) M4x20 bolts with M3 washers installed into the holes on the outside bottom of the cowling (these are the holes that were used to align the exhaust marking template). Apply Blue Thread Lock. Use a 3mm hex driver and tighten well.
2. Drill the spinner and propeller using a drill jig for your engine.
3. Torque the engine bolts to approximately 95 in/lbs.
4. When applying the spinner, be careful not to overtighten the bolts. Be sure to use the provided spinner bolt washers



RADIO INSTALLATION

Required for this section

Components

- Fuselage Assembly
- Receiver
- Receiver Switch
- Aura 8 or 12 Professional (Optional)
- Receiver Batteries
- Hook and Loop Straps
- Adhesive-Backed Hook and Loop Tape
- Tie-Wraps

Tools

- #1 Phillips Screwdriver
- Hobby Knife

Adhesives/Building Materials

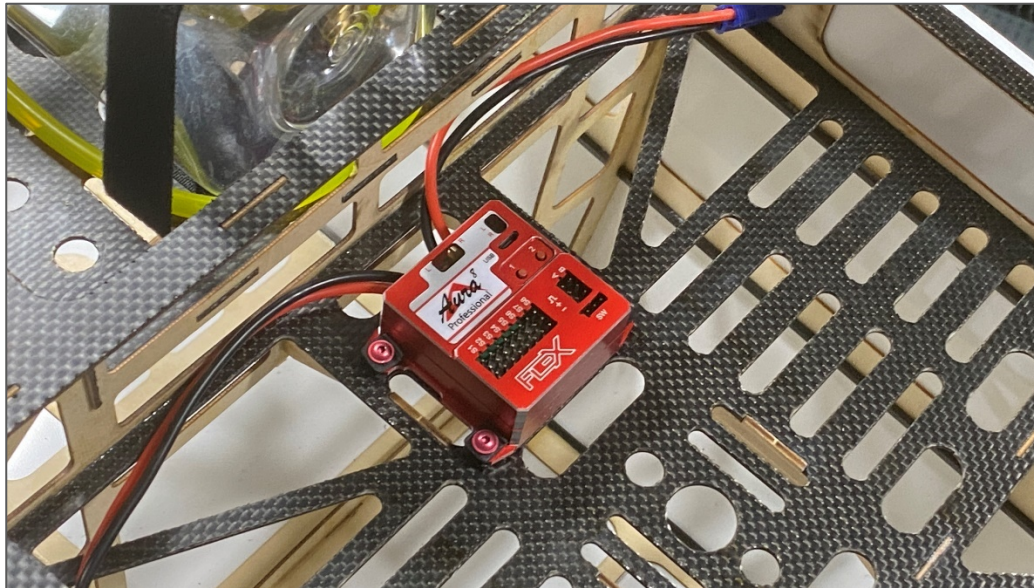

1. If you are using the Aura 8 or 12 Professional AFCS, it should be mounted forward of the rudder servo location in the center of the fuselage as shown in picture above. The Aura program for the Edge 540 120cc G2 can be found in the Aura Config Tool Windows application.
2. Use a #1 Phillips screwdriver to thread an Aura mounting screw into each of the pre-cut holes in the mounting tray. Remove the screw and apply a small amount of thin CA to each of the holes to harden the threads cut by the screw. Let the CA fully cure before mounting the Aura and securing the (4) screws.

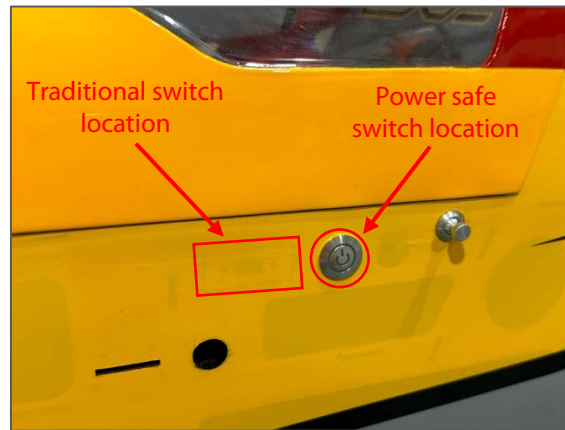

3. Locate the RX/Aura switch just under the canopy. Note that there are switch locations on both sides of the fuselage for both traditional and power safe switches. Remove the covering from the hole of your choice using a hobby knife with a sharp blade and install your RX switch. Use blue thread lock if your switch uses screws with metal-to-metal contact. **DO NOT** use thread lock if your screws thread into plastic!

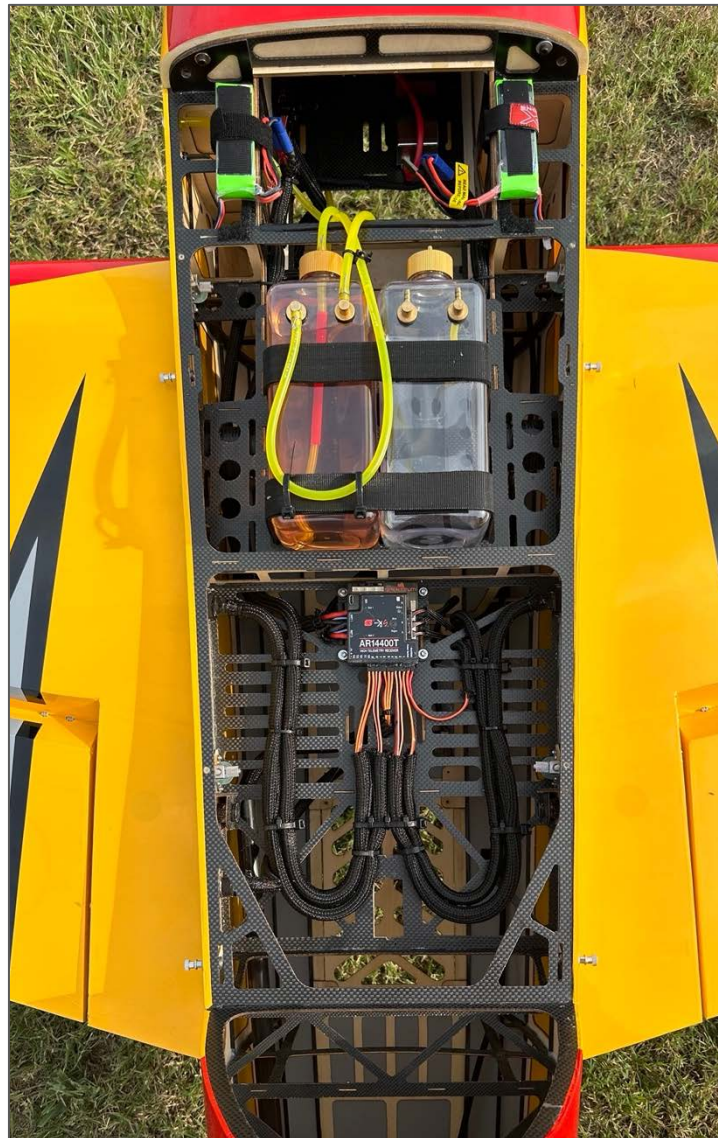

4. Make all the necessary servo connections. Depending on the center of gravity (see the CG section), install your (2) receiver batteries in one of three mounting locations provided in the Edge. They are located as follows:
- Receiver & Rudder Servo Tray
 - Just forward of the fuel tank tray along the sides of the motor box
 - Inside the motor box on the bottom surface of the motor box
 - Of course, batteries can be mounted virtually anywhere you can strap them in.

Use adhesive-backed hook and loop tape and a hook and loop strap to secure each battery in place.

5. Place your receivers in the appropriate area according to your receiver's instruction manual. Note that the carbon structure in the fuselage can cause issues with signal, so route your antennas appropriately.

SIDE FORCE GENERATORS ASSEMBLY

Required for this section

Components

- SFGs (2)
- SFG Spacers (2)

Tools

Adhesives/Building Materials

- Thin CA
- CA accelerator (optional)



1. Align an SFG spacer with the SFG and apply a small amount thin CA around the joint to hold the spacer in place to the SFG. This will assist in the field assembly.
2. Repeat this for the other SFG.

FIELD ASSEMBLY

Required for this section

Components

- Fuselage Assembly
- Main Wings (2)
- Anti-rotation Tube
- WingTube
- Stab Tube
- Canopy Hatch

Tools

Adhesives/Building Materials



1. Pull out the Flex Canopy Speed-Lock knob until it bottoms out, then twist it CW or CCW 1/4 turn. You can now release the knob, and it will stay in the unlocked position (canopy open). Do the same to the Flex Canopy Speed-Lock on the other side of the fuselage. Proceed and lift the canopy from the rear at a shallow angle and pull back at same time until the two front canopy pins are out of their holes.



2. Unlock the 4 wing Flex Speed-Locks from both right and left side. To unlock them you need to pull out on the knob and then slide it up until it reaches its limit. Note that the Flex Speed-Lock design has a plastic tube extension on the top that shows the unlock position when the tube is sticking out of the top of the airplane frame.



3. Slide the main wing tube and the anti-rotation tube into the fuselage so that they are roughly centered left to right. Slide one of the wing panels over the tube, connect the aileron servos to the servo extensions or MPX connector and fully slide the wing against the fuselage until you see no gap between the wing and the fuselage.

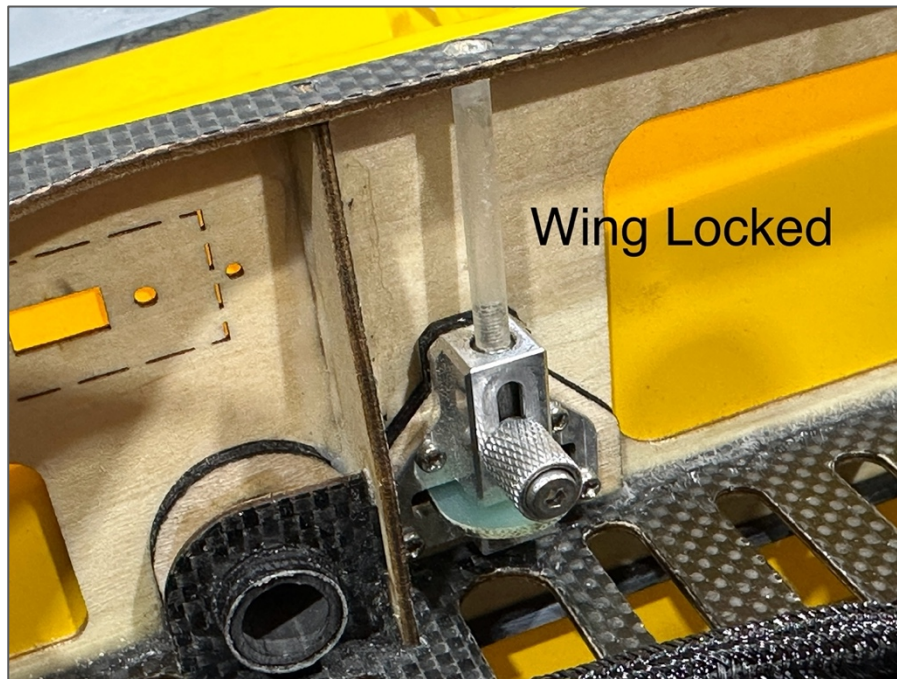

4. Proceed to lock the Flex Speed-Locks by pushing down on the plastic tubes until they are flush with the fuselage, and you hear a “click”. If the plastic tube is not flush with the top of the fuselage, then you know the Flex Speed-Lock is not properly locked. The protruding tube will also prevent the canopy from being installed when the Flex Speed-Locks are not fully locked.

Note: it is not recommended to lock the Flex Speed-Lock by pulling on handle and sliding it down as this does not guarantee that the knob will find the indentation and be in the proper locked position. Pushing on the tube and hearing the “click” is what ensures that it is locked properly.

5. Repeat for the second wing.

Always push down on the plastic tubes until you hear “click” and they sit flush with the fuselage frame.

Make sure you lock all 4 Flex Speed-Locks.



- 6. Unlock the horizontal stabilizer Flex Speed-Locks from both right and left side. To unlock them you need to pull out on the knob and then slide it down until it reaches its limit.
- 7. Slide the horizontal stabilizer tube into the fuselage so that it is roughly centered left to right. Slide one of the horizontal stabs over the tube, connect the elevator servo to the servo extension and fully slide the horizontal stab against the fuselage until it completely seated in the pocket in the fuselage.



- 8. Once the horizontal stab is seated properly lock the Flex Speed-Lock by pushing the knob upwards until it settles into position. Pull out on the horizontal stabilizer to ensure that it is properly locked. Repeat these two steps for the horizontal stabilizer on the other side of the fuselage.

9. Install the canopy hatch back on the fuselage by inserting the two front pins in the fuselage and seat flush to the fuselage. One in place, then proceed to lock the canopy. Turn the Flex Canopy Speed-Lock knob $\frac{1}{4}$ turn CW or CCW and the knob will go in a find lock position. Do the same with the other side. Check that the Flex Speed-Locks are in the locked position by pulling up on the canopy to confirm that it is secure.

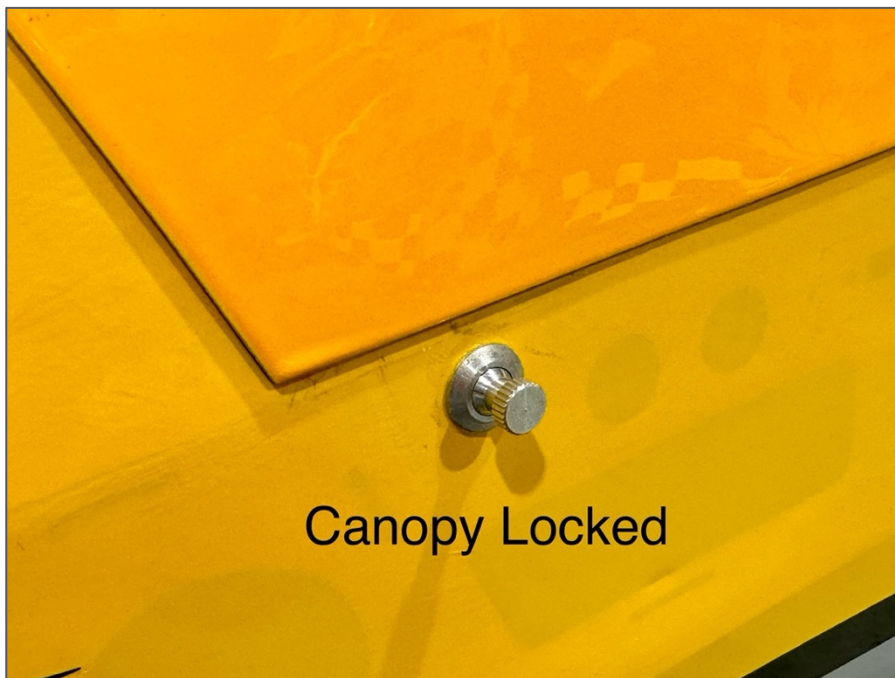

DECAL INSTALLATION

Use the drawings provided below for a guide to apply the decals to your model.

1. Thoroughly clean the model to ensure it is free of oil, fingerprints, and dust.
2. Separate the decals, but do not remove the paper backing.
3. Prepare a dishpan or small bucket with a mixture of warm water and liquid dish detergent. The ratio should be approximately one teaspoon per gallon of water.
4. Submerge the decal into the water/soap mixture and gently remove the paper backing. Removing the backing under water prevents fingerprints from being visible on the back side of the decal
5. Apply some water/soap mixture with your palm to the area desired. Once the area is saturated, position the sticker on the airplane. Even though these are not water transfer decals, using wet application methods allows the sticker to be repositioned, reduces bubbles, and eliminates fingerprints and other blemishes from being visible.
6. Hold the decal in place and use a paper towel to gently wipe most of the water away.
7. Use a soft piece of balsa or something similar to squeegee out the remaining liquid from underneath the decal.
8. Repeat the process until all decals are applied. Do not move, or otherwise touch the model for at least 24 hours to allow adequate time for the remaining water to evaporate.

Edge 540 120cc G2 Green Scheme

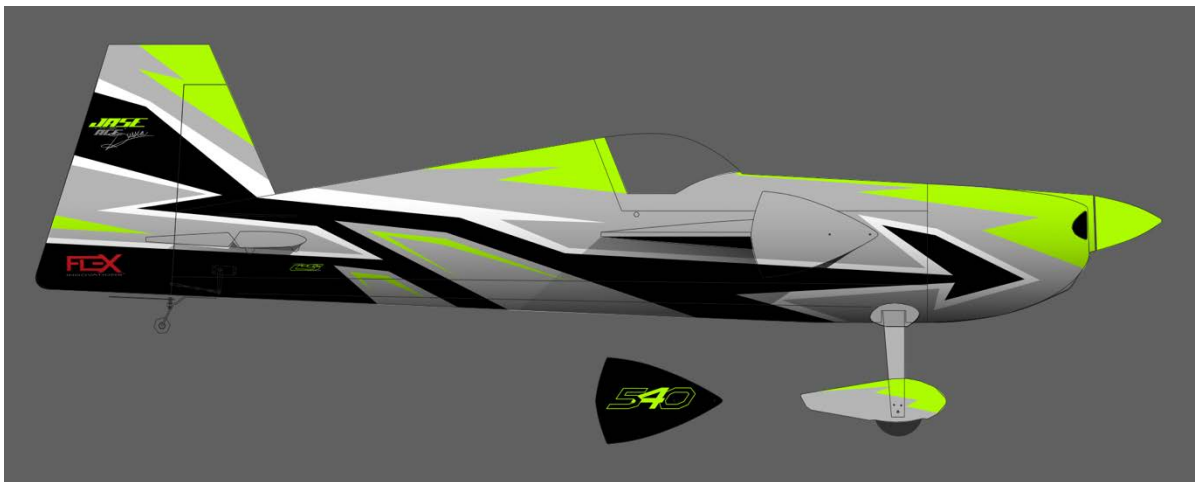

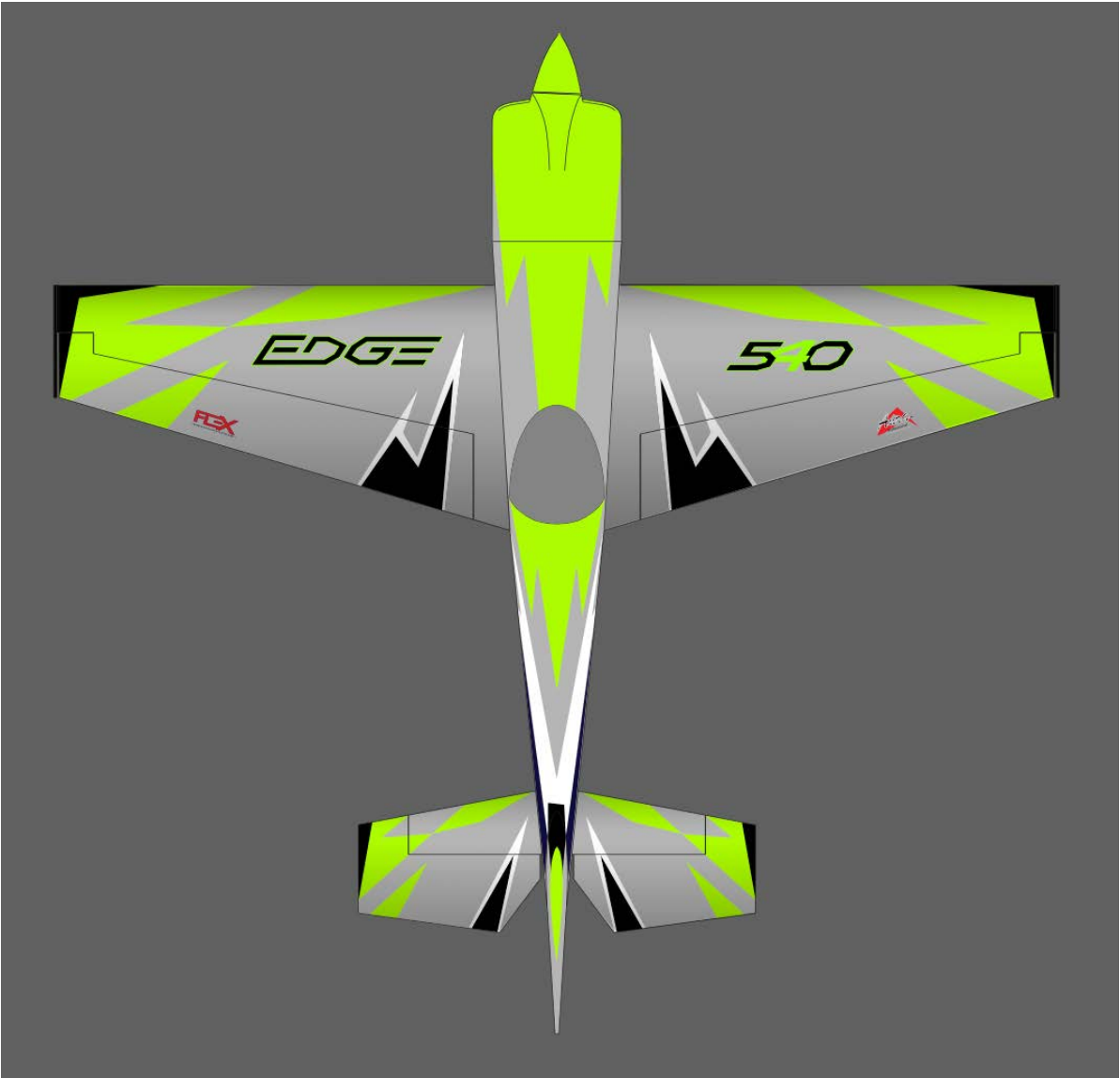
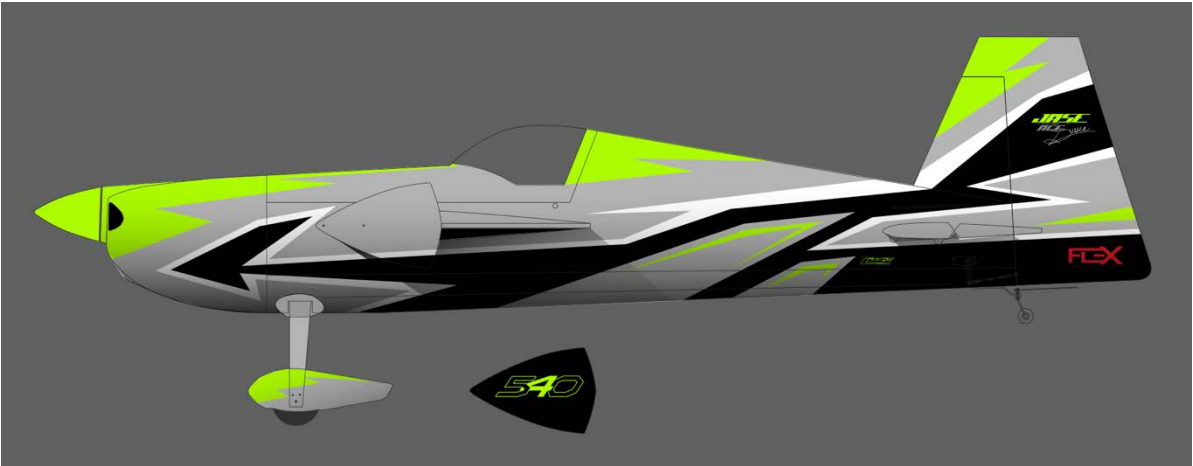

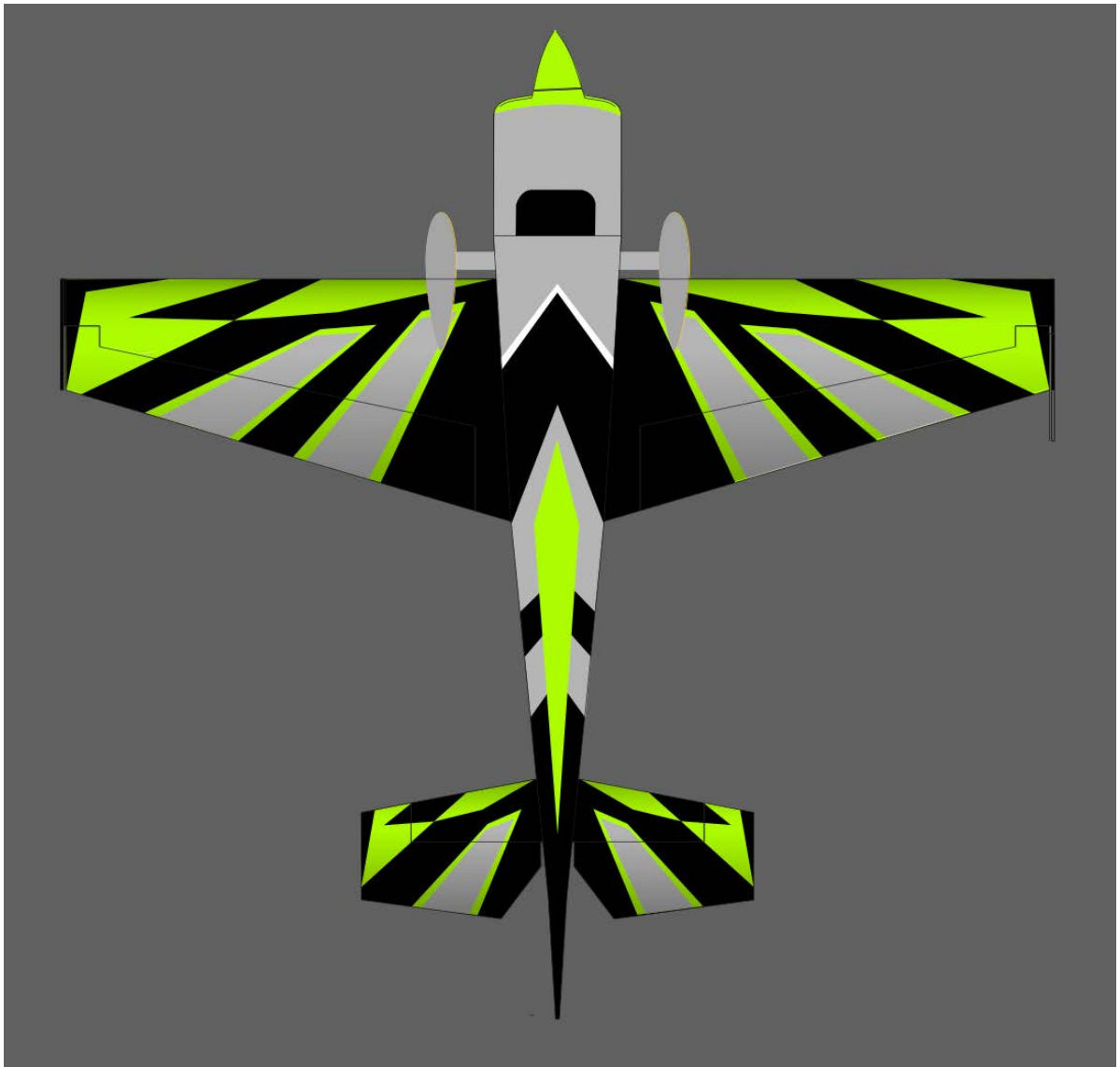

Edge 540 120cc G2 Yellow Scheme

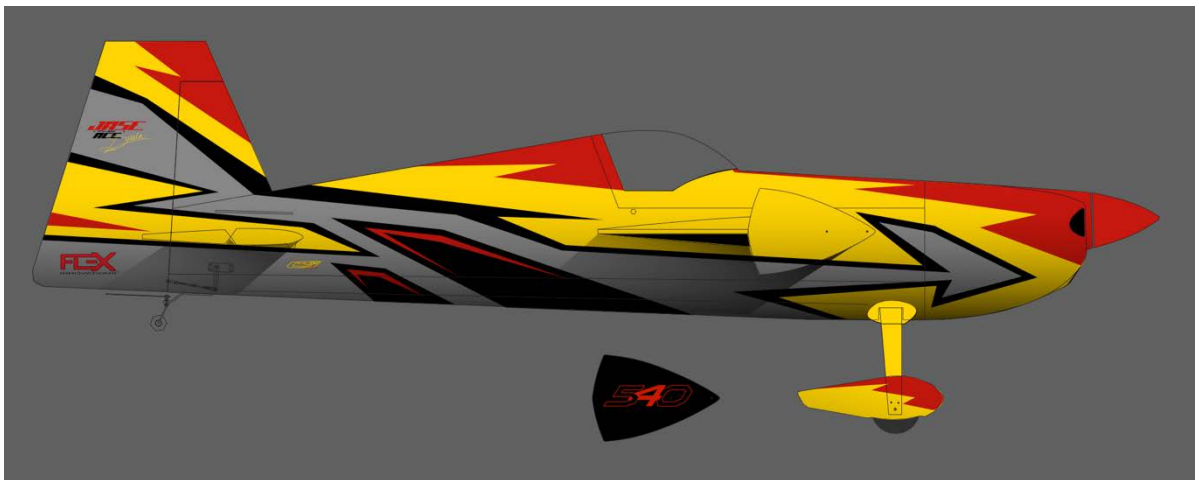

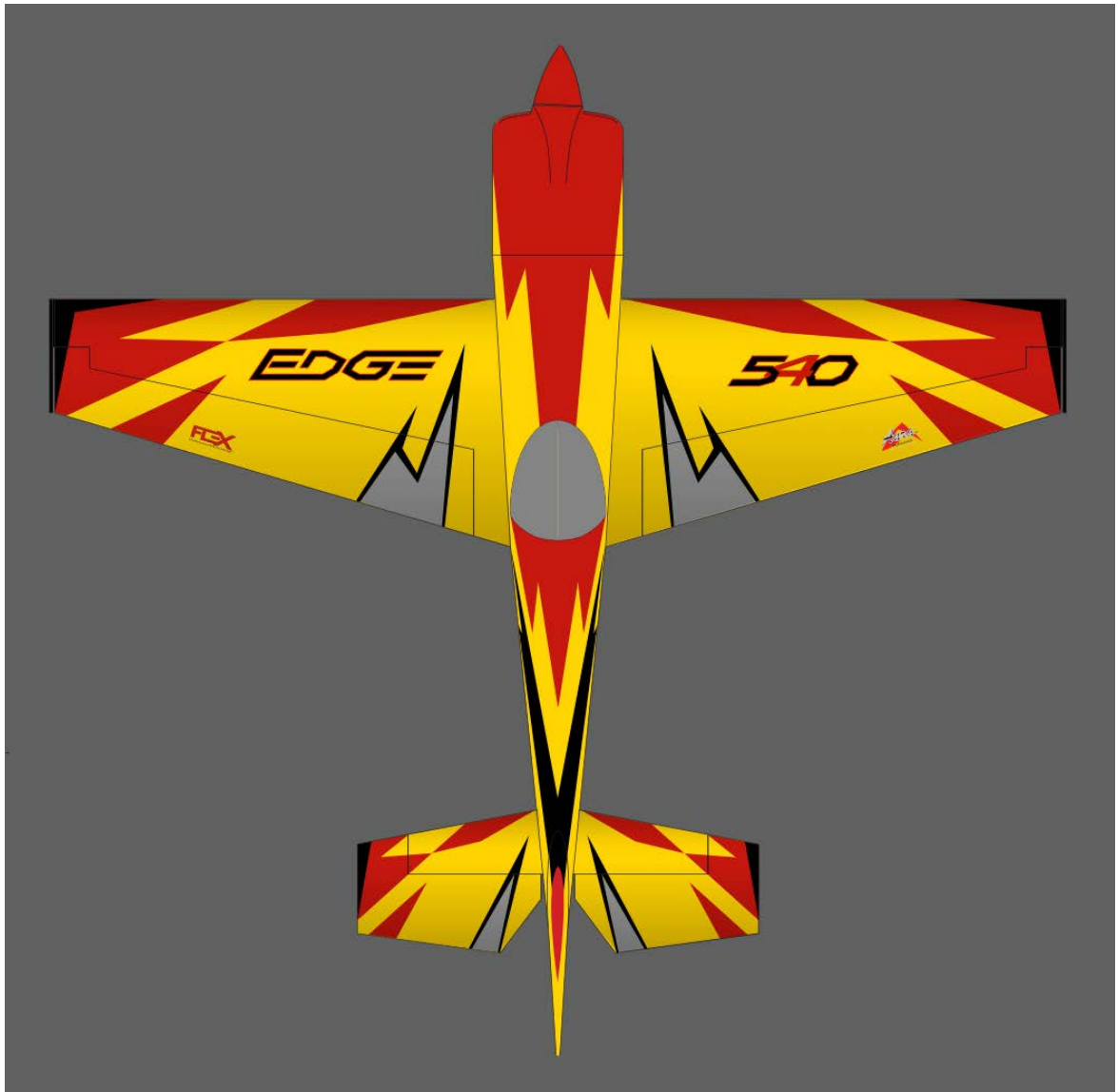
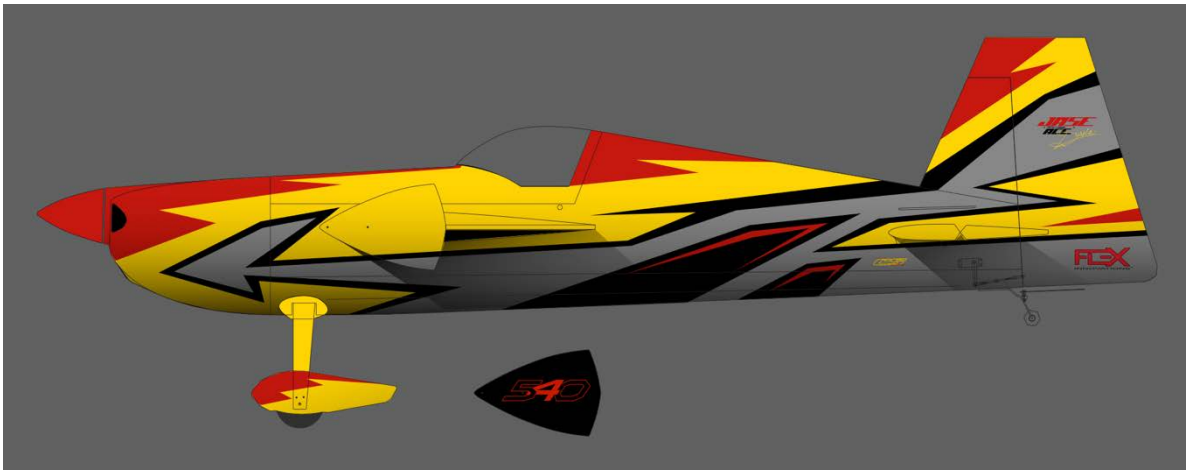

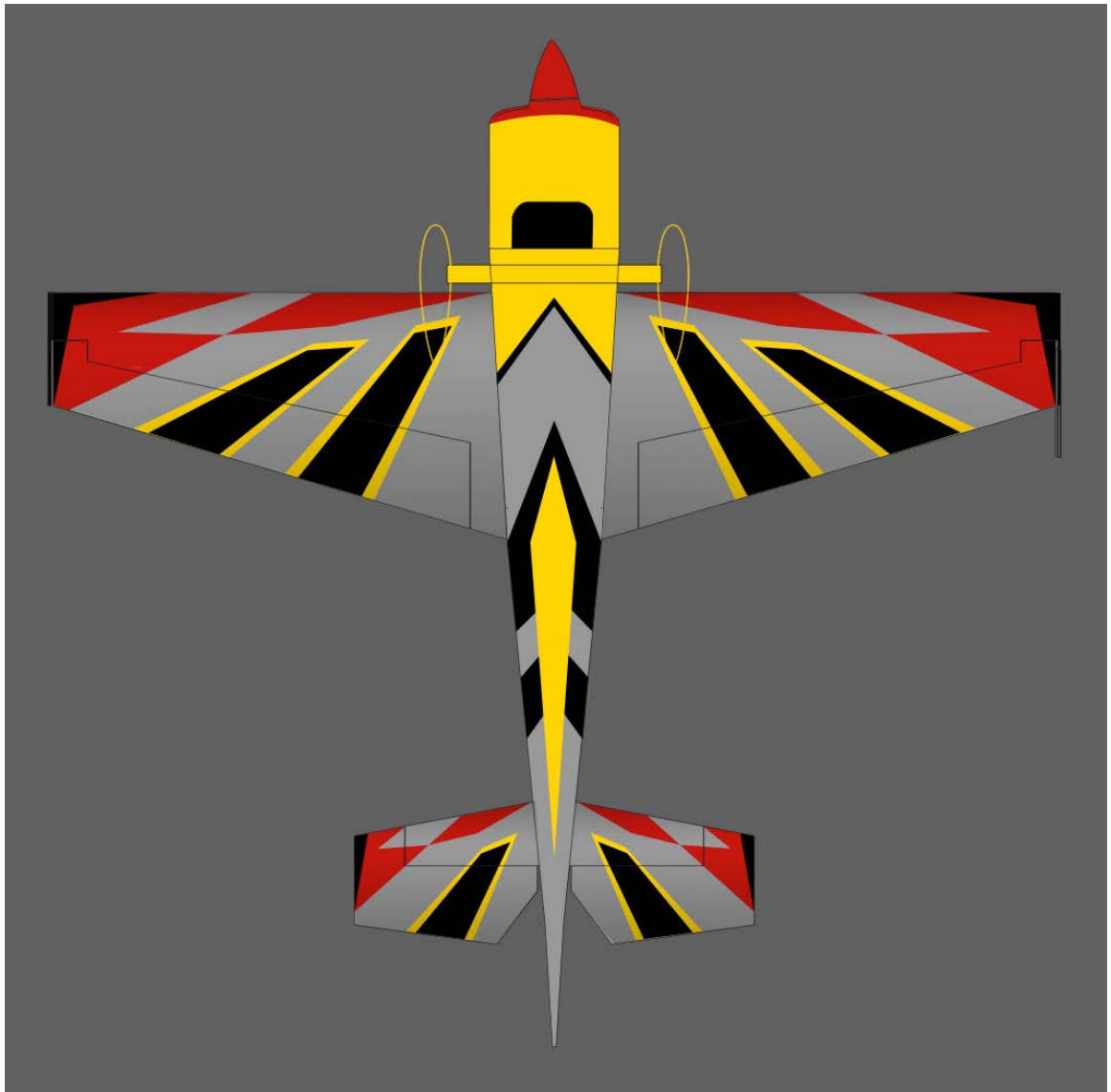

FINAL SETUP AND FLYING NOTES

CENTER OF GRAVITY

Setting the center of gravity (CG) is one of the most important steps for success, particularly with a new airplane. The Flex Innovations Edge 540 120cc G2 is a high-performance airplane with large control surface throws, and a very high thrust to weight ratio. These factors combined make the Edge a very enjoyable aircraft to fly, but if the center of gravity is not within an acceptable range, it will make the airplane difficult, if not impossible, to control. To have the most success and enjoyment from your Edge 540 120cc G2, please follow the next few steps very carefully.

Before checking the CG of your model please ensure that all the components are installed in your airplane. This means the batteries, servos, linkages, hardware, propeller, spinner, hatches; everything. The airplane must be in ready-to-fly condition (without fuel), otherwise the measurement will not be accurate.

There are several methods for determining center of gravity, from using a CG machine, to using fingers and a friend. Regardless of the method used, ensure that the tests are accurate and repeatable. If there are any inconsistencies between measurements, work to isolate the source of the error(s) making sure that the test can be repeated with the same results.

The location of the center of gravity for the Edge 540 120cc G2 is 6-9/16-inches (167mm) AFT from the LEADING EDGE of the WING. It is critical that the starting point for your model be at this point. This measurement is determined from many test flights by Jase Dussia.

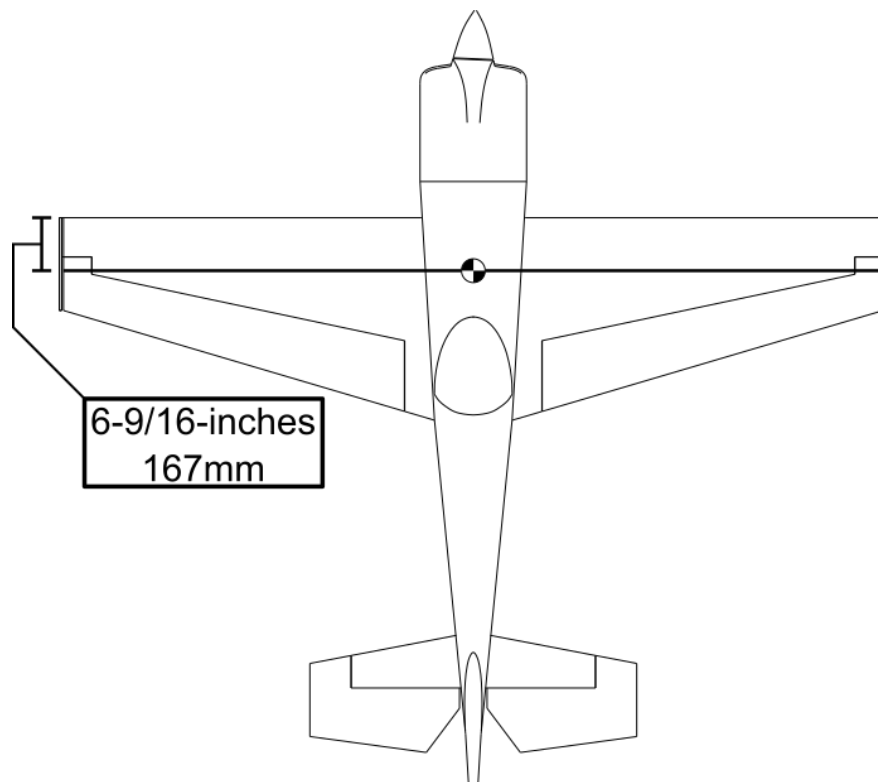

Jase's Pro Tip:

- The measurement noted is the best CG location for flying the Edge 540 120cc G2, and where all tweaks to the airframe have been made. The aircraft is safe to fly within the range of 6-inches (153mm) to 6-23/32-inches (171mm) when measured from the leading edge of the wing but may not be flying at its optimized location.

AURA 8 PROFESSIONAL

If you choose to use Aura 8 Professional AFCS, you can find the Edge 540 120cc Aura setup in the Aura Config Tool by going to File > New Aura Config File Wizard.

STARTING CONTROL SURFACE THROWS AND EXPONENTIAL

The following throws and exponential have been tested thoroughly during the development of the airplane and have been determined to be the optimal starting point for the Ultimate 70cc. As you become more familiar with the airplane, you may tweak the rates and expos to better suit your flying style, but these numbers provide a very good starting point.

NOTE: Throws are measured in degrees. We recommend you download an App on your phone to measure degrees. Since expo directions vary by transmitter manufacturer, all expos listed below are those that make the control feel softer around the stick's center position.

Edge 540 120cc G2 Control Throws and Expos

| | Low Rate | | High Rate | |
|----------------------|----------|-------|-------------------|-------------------|
| | Up | Down | Up | Down |
| Aileron | 20.5 | 20 | 38 | 37 |
| Elevator | 20-30 | 20-30 | 60-65 | 60-65 |
| Rudder | 20 | 20 | Maximum Available | Maximum Available |
| Aileron Expo | 35% | 35% | 55% | 55% |
| Elevator Expo | 25% | 25% | 50% | 50% |
| Rudder Expo | 25% | 25% | 50% | 50% |

Jase's Pro Tips:

- The low rate noted in the chart above includes enough aileron throw to do snap rolls. If you are sensitive to the ailerons, you can reduce value to 17 degrees for the first flights until you can adjust to your personal tastes.
- For high rudder rate, increase the travel until the control horn nearly touches the fuselage, and be sure to match both directions.

RANGE TESTING

Carefully follow the binding and range testing instructions included with your radio equipment. If there are any issues passing the test range, please consult your transmitter and receiver manuals or contact your transmitter and receiver manufacturer to determine the appropriate solution before attempting to fly.

BEFORE FIRST FLIGHT

Before going to the field for your first flight, please go over the finished, fully assembled model at home. The key to a successful first flight is preparation and ensuring that your plane is airworthy.

1. For optimal performance of your model, balance your propeller and spinner. Most propellers are balanced fairly-well out of the package; however, some fine-tuning can make a mediocre propeller perform great. An out-of-balance propeller or spinner can wreak havoc on the electronic components in the airplane, as well as prematurely shorten the life span of the engine, servos or even the model itself. A balanced propeller will be quieter, generate more thrust, produce less vibration, and operate more efficiently than one that is not balanced.
2. Re-check all linkages and connections, including those that may have been assembled by the factory. Ensure pushrods are sufficiently threaded into ball links, ensure that all metal-to-metal connections have thread lock applied and ensure that all control surfaces move freely and in their proper direction.
3. Verify proper functioning, break-in, and operation of your engine choice. Ensure that the fuel-air mixture is correct, and that the engine is producing full power. If you are not familiar with gas engines, ask for the assistance of a more experienced pilot in your area or speak with your engine manufacturer.
4. Secure any loose wiring inside the fuselage or wings in such a way that they do not rub or chafe.
5. Ensure that all batteries (transmitter, receiver, ignition, or flight packs) are fully charged prior to leaving for the flying field.
6. Take a few moments to assemble the airplane away from commotion, talkative onlookers, or any other distractions. Ensure that all connections are properly made and secured, the wing bolts are tight and take a few minutes to plan out your first flight.
7. If your gas engine is new, avoid prolonged full throttle runs and vertical climbs. Limit the first few flights to a short flight time. Start off short, gradually lengthening the flight times as you become comfortable with the performance of your engine. Six minutes is a good time to limit your first flights to. As you become more familiar with the airplane and begin to fly it in a more aggressive manner, monitor the temperature of the engine and adjust the fuel-air mixture according to your engine manufacturer's recommendations.

AMA SAFETY CODE

When flying your aircraft, we recommend following the guidelines set by the Academy of Model Aeronautics (AMA). You can find their Safety handbook as well as more information on the AMA at their website, located at the address below.

<https://www.modelaircraft.org/>

REPLACEMENT PARTS

| | |
|-----------|--|
| FPM2400A | Edge 540 120cc G2 ARF Yellow |
| FPM2400B | Edge 540 120cc G2 ARF Green |
| FPM2401A | Edge 540 120cc G2 Fuselage Yellow |
| FPM2401B | Edge 540 120cc G2 Fuselage Green |
| FPM2402LA | Edge 540 120cc G2 Left Wing with Horns Yellow |
| FPM2402LB | Edge 540 120cc G2 Left Wing with Horns Green |
| FPM2402RA | Edge 540 120cc G2 Right Wing with Horns Yellow |
| FPM2402RB | Edge 540 120cc G2 Right Wing with Horns Green |
| FPM2403A | Edge 540 120cc G2 Horizontal Stab and Elevator with Horns Yellow |
| FPM2403B | Edge 540 120cc G2 Horizontal Stab and Elevator with Horns Green |
| FPM2404A | Edge 540 120cc G2 Rudder with Horns Yellow |
| FPM2404B | Edge 540 120cc G2 Rudder with Horns Green |
| FPM2405A | Edge 540 120cc G2 Cowling with Template Yellow |
| FPM2405B | Edge 540 120cc G2 Cowling with Template Green |
| FPM2406A | Edge 540 120cc G2 Canopy with Cockpit Yellow |
| FPM2406B | Edge 540 120cc G2 Canopy with Cockpit Green |
| FPM2407A | Edge 540 120cc G2 Landing Gear Yellow (Painted Yellow) |
| FPM2407B | Edge 540 120cc G2 Landing Gear Green (Painted Silver) |
| FPM2408A | Edge 540 120cc G2 Wheel Pants Yellow |
| FPM2408B | Edge 540 120cc G2 Wheel Pants Green |
| FPM2409 | Edge 540 120cc G2 Wing Tubes and Stab Tubes |
| FPM2410 | Edge 540 120cc G2 Tailwheel Set with hardware |
| FPM2411 | Edge 540 120cc G2 Main Wheels w/ Axles |
| FPM2412 | Edge 540 120cc G2 Linkage and Control Horn Set |
| FPM2413 | Edge 540 120cc G2 Hardware Set |
| FPM2415A | Edge 540 120cc G2 Decal Set Yellow |
| FPM2415B | Edge 540 120cc G2 Decal Set Green |
| FPM2416A | Edge 540 120cc G2 Pilot Figure Yellow |
| FPM2416B | Edge 540 120cc G2 Pilot Figure Green |
| FPM2417A | Edge 540 120cc G2 Landing Gear Cuffs Yellow |
| FPM2417B | Edge 540 120cc G2 Landing Gear Cuffs Green |
| FPM2418 | Edge 540 120cc G2 Engine Baffling |
| FPM2419 | Edge 540 120cc G2 Removable Rudder Wire |
| FPM2420 | Edge 540 120cc G2 Flex Speed Lock WING (1) |

| | |
|----------|---|
| FPM2421 | Edge 540 120cc G2 Flex Speed Locks CANOPY (1) |
| FPM2422 | Edge 540 120cc G2 Flex Speed Locks STAB (1) |
| FPMA1035 | Flex 120cc Wheel Pant Savers (2) |
| FPM2424 | Edge 540 120cc G2 Laser Cut Wood Parts |
| FPM2425A | Edge 540 120cc G2 Foam Cockpit Set Yellow |
| FPM2425B | Edge 540 120cc G2 Foam Cockpit Set Green |
| FPM1324A | 5" Carbon Spinner Solid Green |
| FPM1324B | 5" Carbon Spinner Solid Red |
| FPM2426A | 5" Carbon Spinner Yellow/Red/Grey Edge G2 Scheme |
| FPM2426B | 5" Carbon Spinner Green/Silver/White/Black Edge G2 Scheme |
| FPM1316 | Oracover Royal Green, 1m x 2m Roll |

OPTIONAL ACCESSORIES

| | |
|----------------|--|
| FPM1314 | Edge 540 120cc ARF Premium Wing and Tail Bag Set |
| FPM2416A | Edge 540 120cc G2 Pilot Figure Yellow |
| FPM2416B | Edge 540 120cc G2 Pilot Figure Green |
| FPMDA120 | Desert Aircraft DA-120cc Engine |
| FPMDA120MUFLR | DA120 Muffler |
| FPMGP123 | GP 123cc V2 Engine with Mufflers |
| FPM1024A | 5-inch Carbon Fiber Spinner, Green |
| FPM1024B | 5-inch Carbon Fiber Spinner, Red |
| DP1000 | Dualsky DP1000 Brushless Smoke Pump |
| FPM1623 | 32oz Lightweight Fuel/Smoke Tank |
| FPMPFC2895CF | Falcon 28x9.5 Carbon Fiber Propeller |
| FPZA1036 | Aluminum Servo Arm 2-in Clamping (25T) |
| FPZA1037 | Aluminum Servo Arm 4-in Clamping (25T) |
| FPZA1040 | Servo Connector Safety Clip |
| FPZAURA08PRO | Aura 8 Professional AFCS |
| FPZAURA12PRO | Aura 12 Professional AFCS |
| FPZBR20002S15 | 2000 mAh 2s 15C JR/EC3 Connector RX Li-Po Battery Pack |
| FPZDS49010BLHV | Potenza DS49010BLHV Brushless Servo |
| FPMA1049 | McFueled Fuel Dot |

LIMITED WARRANTY

Warranty Coverage

Flex Innovations LLC and its authorized resellers (“Flex”) warrant to the original purchaser that this product (the “Product”) will be free from defects in materials and workmanship at the date of purchase.

Outside of Coverage

The warranty is not transferable and does not cover:

- (a) Products with more than 45 days after the purchase date
- (b) Damage due to acts of God, accident, misuse, abuse, negligence, commercial use, or due to improper use, installation, operation, or maintenance
- (c) Damage to other components or assemblies associated with the use of the Product.
- (d) Modification of or to any part of the Product
- (e) Product not purchased from an authorized Flex Innovations dealer or distributor.
- (f) Product that has been partially, or fully assembled
- (g) Shipping damage
- (h) Cosmetic damage
- (i) Services or labor associated with the repair, use or assembly of the Product.

OTHER THAN THE EXPRESS WARRANTY ABOVE, FLEX MAKES NO OTHER WARRANTY REPRESENTATION, AND HEREBY DISCLAIMS ALL IMPLIED WARRANTIES, INCLUDING, WITHOUT LIMITATION, THE IMPLIED WARRANTIES OF NONINFRINGEMENT, MERCHANTABILITY AND FITNESS FOR A PARTICULAR PURPOSE. THE PURCHASER ACKNOWLEDGES THAT THEY ALONE HAVE DETERMINED THAT THE PRODUCT WILL SUITABLY MEET THE REQUIREMENTS OF THE PURCHASER’S INTENDED USE.

Purchaser’s Remedy

Flex’s sole obligation and purchaser’s sole and exclusive remedy shall be that Flex will, at its option, either (i) service, (ii) replace any part of the Product determined by Flex to be defective, or (iii) replace the Product determined by Flex to be defective. Flex reserves the right to inspect all Product(s) involved in a warranty claim. Service or replacement decisions are at the sole discretion of Flex. Proof of purchase is required for all warranty claims. **SERVICE OR REPLACEMENT AS PROVIDED UNDER THIS WARRANTY IS THE PURCHASER’S SOLE AND EXCLUSIVE REMEDY.**

Limitation of Liability

FLEX SHALL NOT BE LIABLE FOR SPECIAL, INDIRECT, INCIDENTAL OR CONSEQUENTIAL DAMAGES, LOSS OF WAY, REGARDLESS OF WHETHER SUCH CLAIM IS BASED IN CONTRACT, WARRANTY, TORT, NEGLIGENCE, STRICT LIABILITY OR ANY OTHER THEORY OF LIABILITY, EVEN IF FLEX HAS BEEN ADVISED OF THE POSSIBILITY OF SUCH DAMAGES.

Further, in no event shall the liability of Flex exceed the individual price of the Product on which liability is asserted. As Flex has no control over use, setup, assembly, modification or misuse, no liability shall be assumed nor accepted for any resulting damage and/or injury. By the act of use, setup or assembly, the user accepts all resulting liability. If you as the purchaser or user are not prepared to accept the liability associated with the use of the Product, purchaser is advised to return the Product immediately in new and unused condition to the place of purchase.

Law

These terms are governed by Florida law (without regard to conflict of law of principals). This warranty gives you specific legal rights, and you may also have other rights which vary from state to state. FLEX RESERVES THE RIGHT TO MODIFY THIS WARRANTY AT ANY TIME WITHOUT NOTICE.

Questions & Assistance

Contact us by:

E-Mail – support@flexinnovations.com

Phone – 1 (866) 310-3539

Inspection or Services

If this Product needs to be inspected or serviced and is compliant in the region you live and use the Product in, please contact your regional Flex authorized reseller. Pack the Product securely using the original shipping carton. Please note that both the inner and outer boxes need to be included. The inner box is not designed to withstand the rigors of shipping without additional protection from the outer shipping carton. Ship via a carrier that provides tracking and insurance for lost or damaged parcels, as Flex is not responsible for merchandise until it arrives and is accepted at our facility.

Warranty Requirements

For Warranty consideration, you must include your original sales receipt verifying the proof of purchase date. Provided any warranty conditions have been met, your Product or its defective parts will be replaced or serviced free of charge. Responsibility of shipping charges are as follows:

To Flex from customer, customer is responsible.

To Customer from Flex, Flex is responsible.

Service or replacement decisions are at the sole discretion of Flex.

BUILDING AND FLYING NOTES



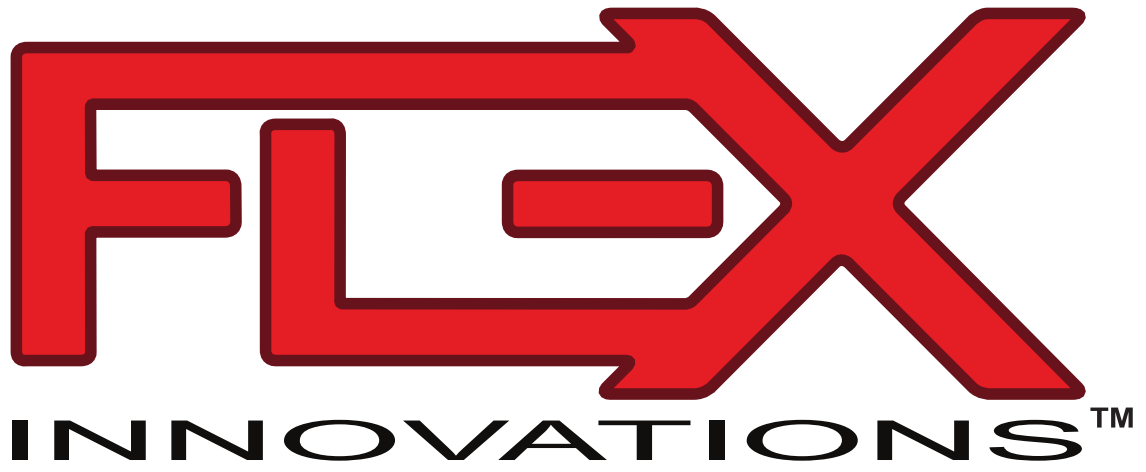

© 2024 Flex Innovations, LLC. All rights reserved.
Potenza™ is a trademark of Flex Innovations LLC

Rev.A
Created 09/2024